



PV Inverters

SUNNY BOY 3300 / 3800

Installation Guide



Table of Contents

1	Notes on this Manual.	5
1.1	Validity	5
1.2	Target Group	5
1.3	Storage of the Manual	5
1.4	Additional Information	5
1.5	Symbols Used	6
2	Safety	7
2.1	Appropriate Usage	7
2.2	Safety Precautions.	8
3	Unpacking.	9
3.1	Packing List	9
3.2	Check for Transport Damage	10
3.3	Identification of the Sunny Boy	10
4	Installation	11
4.1	Selection of the Mounting Location	11
4.1.1	Dimensions and Weight	12
4.1.2	Ambient Conditions.	12
4.1.3	Minimum Clearances	13
4.1.4	Position	13
4.2	Mounting instructions	14
5	Electrical Connection	16
5.1	Overview of the Connection Area	16
5.2	Connection to the Public Grid (AC)	17
5.3	Solar generator connection (DC)	21

5.4	Communication	23
5.4.1	Line-conducted Communication	23
5.4.2	Wireless Communication	25
6	Commissioning	26
6.1	Display Language and LED Display	27
6.1.1	Setting the Display Language	27
6.1.2	LED Display	27
7	Opening and Closing	28
7.1	Opening the Sunny Boy	28
7.2	Closing the Sunny Boy	29
8	Maintenance and Cleaning	30
8.1	Checking Heat Dissipation	30
8.1.1	Cleaning the Fan	30
8.1.2	Cleaning the Fan Gills	31
8.1.3	Testing the Fan	31
8.2	Inspection of the Electronic Solar Switch	33
9	Troubleshooting	34
9.1	Checking the Varistors	34
9.2	Ground fault monitoring	35
10	Decommissioning	36
10.1	Disassembly	36
10.2	Packaging	37
10.3	Storage	37
10.4	Disposal	37
11	Technical Data	38
12	Contact	41

1 Notes on this Manual

1.1 Validity

The manual describes how to install and commission SMA inverters of the types Sunny Boy 3300 and Sunny Boy 3800.

This manual applies for the Sunny Boy 3300 firmware versions GRX33_2.85/2.79 and above and for the Sunny Boy 3800 firmware version GRX38_2.85/2.79 and above. The firmware version is shown in the display after starting the device.

1.2 Target Group

Only qualified electricians may install and commission Sunny Boy units.

1.3 Storage of the Manual

All manuals for the device and for the installed components must be stored in the immediate vicinity of the device, and must be accessible at all times.

1.4 Additional Information

You will find further information on special topics such as designing a line circuit breaker or the description of operating parameters in the download area at www.SMA.de/en.

1.5 Symbols Used

The following types of safety instructions and general information appear in this document as described below:



DANGER!

DANGER indicates a hazardous situation which, if not avoided, will result in death or serious injury.



WARNING!

WARNING indicates a hazardous situation which, if not avoided, could result in death or serious injury.



CAUTION!

CAUTION indicates a hazardous situation which, if not avoided, could result in minor or moderate injury.

NOTICE!

NOTICE indicates a situation that can result in property damage if not avoided.



Information

Information provides tips that are valuable for the optimal installation and operation of your product.

2 Safety

2.1 Appropriate Usage

The Sunny Boy is a PV inverter, which converts the DC current of the PV generator to AC current and feeds it into the public grid.

Principle of a Solar Power System with this Sunny Boy

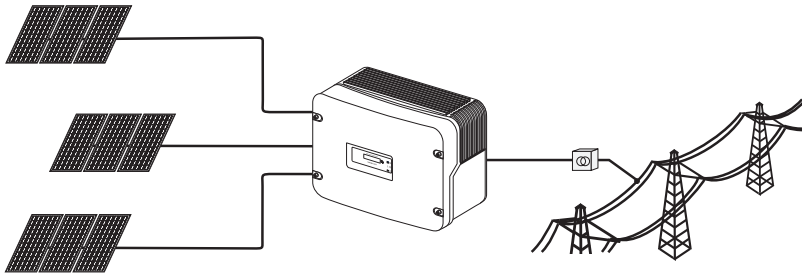

The Sunny Boy may only be operated with PV generators (modules and cabling) of protection class II. Do not connect any sources of energy other than PV modules to the Sunny Boy.

When planning the PV system, ensure that the values comply with the permitted operating range of all components at all times. The free design program "Sunny Design" (www.SMA.de/en/SunnyDesign) will assist you in this. The manufacturer of the PV modules must have approved the modules for use with this Sunny Boy unit. You must also ensure that all measures recommended by the module manufacturer for long-term maintenance of the module properties are taken (see also Technical Information "Module Technology", in the download area of www.SMA.de/en).

Do not use the Sunny Boy for purposes other than those described here. Alternative uses, modifications to the Sunny Boy or the installation of components not expressly recommended or sold by the manufacturer void the warranty claims and operating license.

2.2 Safety Precautions



DANGER!

Lethal danger caused by high voltages in the Sunny Boy!

- All work on the Sunny Boy must be carried out by a qualified personnel.



CAUTION!

Danger of burn injuries due to hot housing parts!

- Do not touch the housing of the Sunny Boy during operation.



Grounding the PV generator

Comply with the local requirements for grounding the modules and the PV generator. SMA Solar Technology recommends connecting and grounding the generator frame and other electricity conducting surfaces in such a way that there is continuous conduction in order to achieve maximum protection for systems and persons.

3 Unpacking

3.1 Packing List

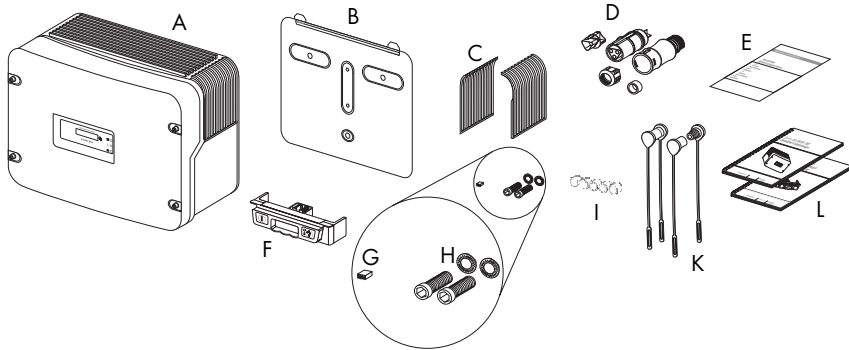

Object	Quantity	Description
A	1	Sunny Boy
B	1	Rear panel
C	2	Handle cover
D	1	Socket element
E	1	Set of documents with explanations and certificates
F	1	Electronic Solar Switch
G	1	Jumper for communication / fan test
H	2	Cylinder head screw and M6 contact disk
I	5	Sealing plugs for rear panel (sealing)
K	2	Cap for PV plug and PV socket
L	2	User manual (Sunny Boy and Electronic Solar Switch)

3.2 Check for Transport Damage

Check the Sunny Boy for visible external damage, such as cracks in the housing or display. Please contact your dealer if you find any damage.

3.3 Identification of the Sunny Boy

You can identify the Sunny Boy by the type label. The type label is found on the right-hand side of the housing.

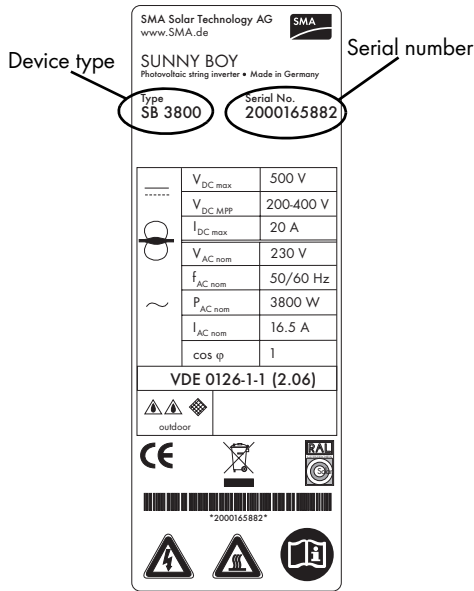

4 Installation

4.1 Selection of the Mounting Location

**DANGER!****Danger to life due to fire or explosion!**

Despite careful construction, a fire can occur with electrical devices.

Do not install the Sunny Boy

- on flammable construction materials,
- in areas where highly flammable materials are stored,
- in potentially explosive areas!

**CAUTION!****Danger of burn injuries due to hot housing parts!**

- Mount the Sunny Boy in such a way that it cannot be touched inadvertently during operation.

4.1.1 Dimensions and Weight

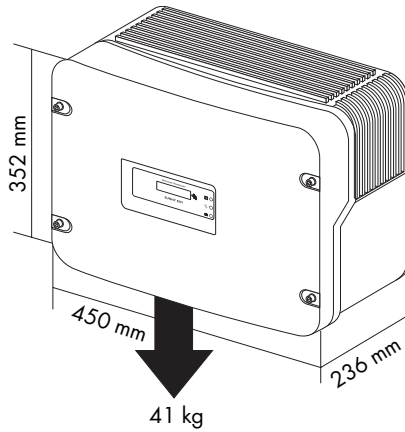

4.1.2 Ambient Conditions

- The mounting location and mounting method must be suitable for the weight and dimensions.
- Mount on a solid surface.
- The mounting location must be accessible at all times (do not mount in inaccessible locations).
- The Sunny Boy must be easy to remove from the mounting location at any time.
- The ambient temperature should be between $-25\text{ }^{\circ}\text{C}$ and $+60\text{ }^{\circ}\text{C}$ to guarantee optimal operation.
- Do not expose the Sunny Boy to direct sunlight, so as to avoid power reduction due to excessive heating.
- In living areas, do not install the unit on plasterboard walls, etc. so as to avoid audible vibrations.

The Sunny Boy can make noises when in use which may be perceived as a nuisance in a living area.

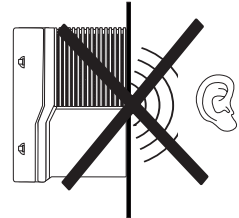

4.1.3 Minimum Clearances

Observe the following minimum clearances to walls, other devices or objects to guarantee sufficient heat dissipation and enough space for removing the Electronic Solar Switch.

Direction	Minimum clearance
Sides	30 cm
Above	20 cm
Bottom	50 cm
Front	5 cm

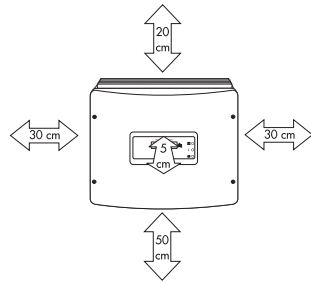

Multiple Sunny Boys installed in areas with high ambient temperatures

If necessary, increase the clearances between the individual Sunny Boys, and ensure that there is enough ventilation to ensure sufficient cooling of the Sunny Boys.

4.1.4 Position

- Vertical installation or tilted backwards by max. 45°.

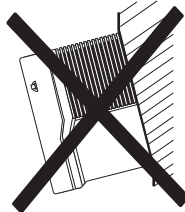
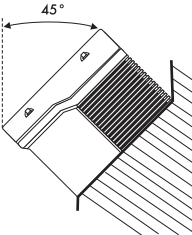
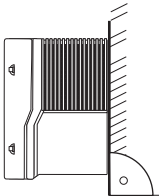

- Never install the device with a forward tilt.
- Do not install horizontally.
- Install at eye level to allow operating modes to be read at all times.

4.2 Mounting instructions



CAUTION!

Risk of injury due to the heavy weight of the Sunny Boy!

- Take the Sunny Boys weight of 41 kg into account.

1. Use the rear panel as a drilling template and mark the positions of the drill holes.

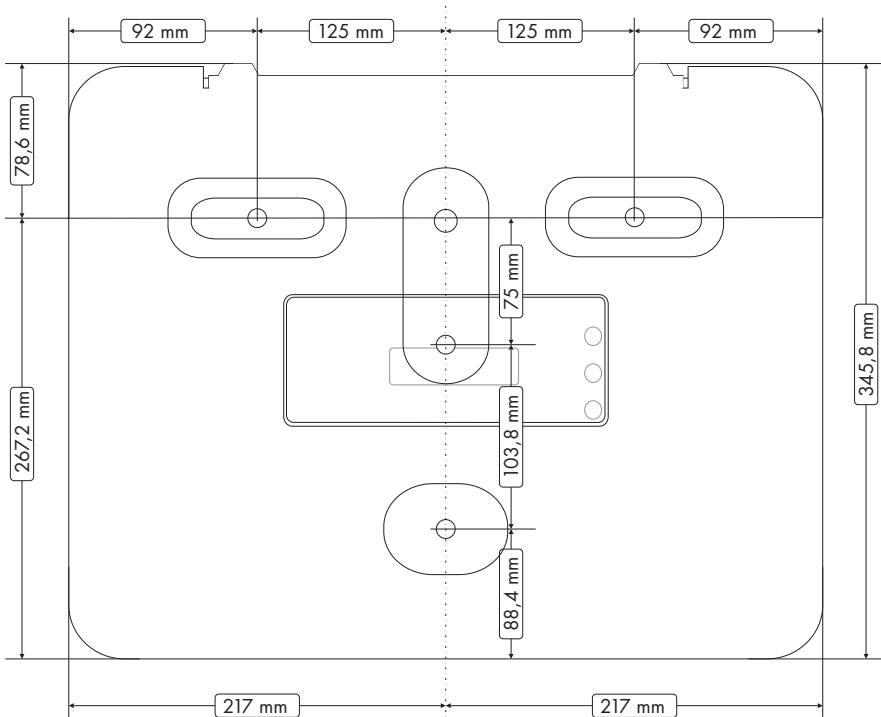

Mounting material

When mounting the rear panel, use fastening material suitable for the mounting surface. Take the weight of the Sunny Boy into account!

2. Close all the unnecessary holes in the rear panel using the sealing plugs provided in the accessories kit. Insert the sealing plugs in the rear panel from the outside (the side that will later be placed against the wall).
3. Mount the rear panel.
4. Attach the Sunny Boy by hanging its upper mounting slots onto the rear panel, so that both mounting plates at the top of the rear panel are fed through the cutouts.

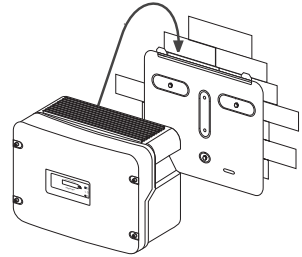
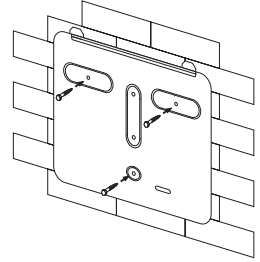

Visual inspection: The Sunny Boy is only correctly mounted when both rear panel mounting plates slightly protrude through the cutouts.

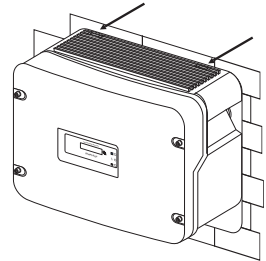

5. Secure the Sunny Boy in position by screwing the supplied M6 contact screw, situated on the underside of the housing. Use the supplied washer, with the tothing against the housing. Tighten the screw with a torque of approximately 5 Nm.
6. Ensure the unit is correctly in place. The rear panel is designed so that the Sunny Boy tilts slightly backwards on a perfectly vertical wall.
7. Close the recessed grips with the fan gills provided in the accessories kit. To help you identify the sides, "links/left" or "rechts/right" is printed on the inside of the fan gills.

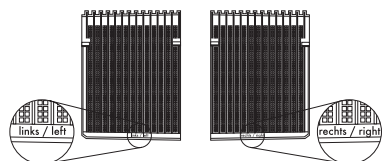
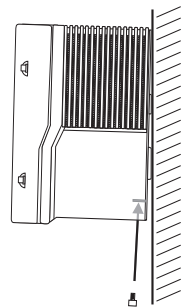

5 Electrical Connection

NOTICE!

Static discharges can damage the Sunny Boy!

- Before you touch a component inside the Sunny Boy ground yourself by touching PE or a grounded object.

5.1 Overview of the Connection Area

The following diagram gives a schematic overview of the various components and connection points inside the Sunny Boy with the cover removed:

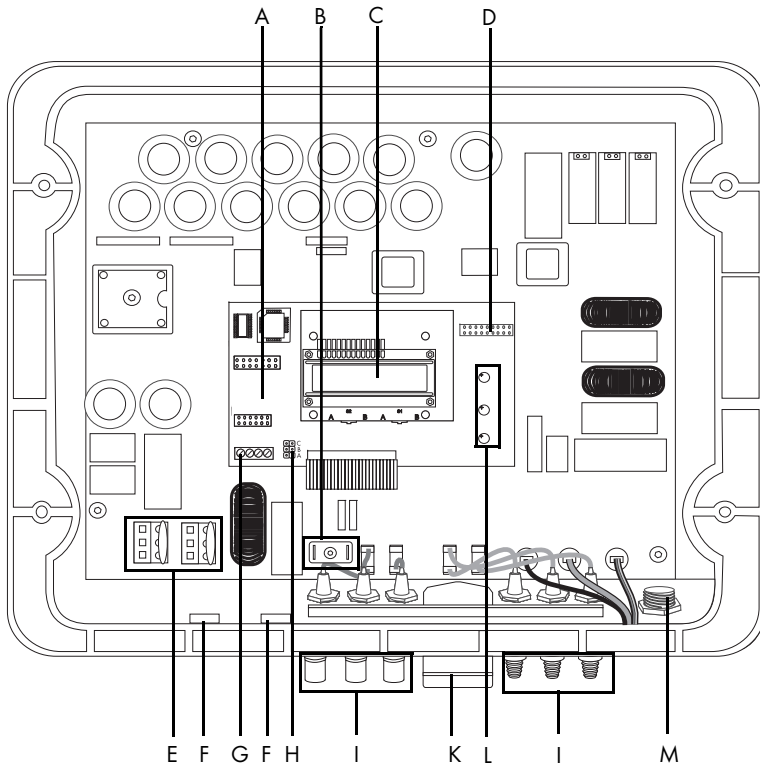

Object	Description
A	Communication socket
B	Flat connection for grounding the cable shield with line-conducted communication
C	Sunny Display
D	Jumper slot for fan test
E	Varistors
F	Housing opening with sealing plugs for communication
G	Communication terminal
H	Jumper slot for communication
I	PV input plug
K	Electronic Solar Switch (ESS)
L	Operating status LEDs
M	AC plug for grid connection

5.2 Connection to the Public Grid (AC)

Low voltage grid 220 V – 240 V

Comply with the connection regulations of your local grid operator.

The Sunny Boy must have a three-wire connection to the grid (L, N, PE).

The grid connection terminals on the AC connection socket included in the accessories kit can take wires with a cross-section of up to 4 mm².

The AC connection socket accessories kit contains two sealing rings for the different cable diameters. The threaded sleeve comes from the factory already equipped with a sealing ring for cable diameters from 10 to 14 mm. If you want to install cable with a diameter of between 6 and 10 mm, you have to exchange the sealing ring with the one included in the accessories kit.

Cable requirements

External diameter

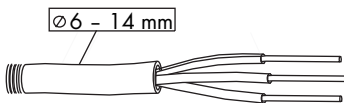

Cable design

For optimum operation of the Sunny Boy the grid impedance of the AC cable must not exceed 1 Ohm. This is necessary, amongst other things, for the correct operation of the Sunny Boy.

The cable cross-section should be sized using the "Sunny Design" design program (www.SMA.de/en/SunnyDesign) so that output losses do not exceed 1 % at nominal power.

The maximum cable lengths are shown in the following table. Do not exceed the maximum cable length.

Cable cross-section	Max. cable length	
	Sunny Boy 3300	Sunny Boy 3800
4 mm ²	18.5 m	16 m

Load disconnection unit

The maximal permissible rating is located in the technical data (page 38).



DANGER!
Risk of lethal burns!

When a generator (Sunny Boy) and a consumer are connected to the same line circuit breaker, the protective function of the line circuit breaker is no longer guaranteed. The current from the Sunny Boy and the grid can add up to overcurrent which is not detected by the line circuit breaker.

- Never connect loads between the Sunny Boy and the line circuit breaker without protection.
- Always install separate fuses for loads.

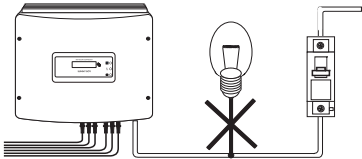



Load disconnection unit

A circuit breaker's load disconnecting properties can be utilized to disconnect the Sunny Boy from the grid underload.

A screw type fuse element, e.g. D system (Diazed) or D0 system (Neozed) has no load disconnecting properties and thus may be used as cable protection, but not as a load disconnection unit.

Upon disconnection under load, the fuse element may be destroyed or its functionality may be impaired by contact burning.

Connection procedure

1. Check the grid voltage and compare it with "Vac" on the type label.

The exact operating range of the Sunny Boy is specified in the operating parameters. You will find the relevant document in the download area at www.SMA.de/en.

2. Switch off the line circuit breaker and secure it to prevent it from being reactivated.
3. If necessary change the sealing ring of the threaded sleeve. Pull the sealing ring out of the threaded sleeve and insert a smaller sealing ring.
4. Slide the pressure screw over the AC connection cable.
5. Slide the threaded sleeve with the suitable sealing ring over the AC cable.

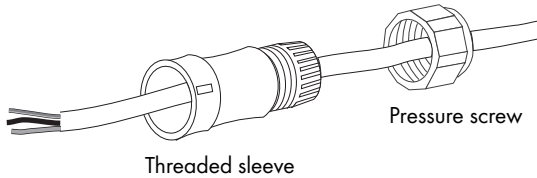

6. Bend the AC cable with a radius of at least four times the cable diameter.

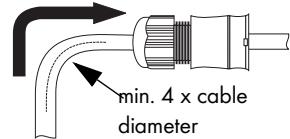

7. Shorten the cable.

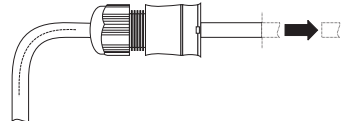

8. Insert the protective earth PE (green-yellow) in the screw terminal with the earth sign on the socket element and tighten the screw. The PE protective earth must be longer than the connected wires of N and L.
9. Insert the neutral conductor N (blue) in the screw terminal N on the socket element and tighten the screw.
10. Insert the live wire L (brown or black) in the screw terminal L and tighten the screw.

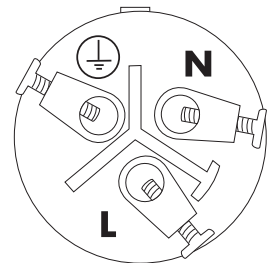

DANGER!
Danger to life due to non-earthed housing!

When laying the AC cable, the PE conductor and the other conductors can be extracted from the socket element after they have been connected.

- Make sure the wires are securely connected.
- Do not bend the AC cable once it has been connected.
- Do not subject the socket element to heavy loads.

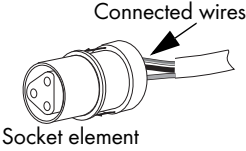

11. Press the threaded sleeve into the socket element until it audibly engages.

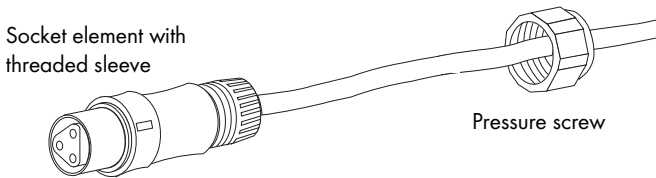

12. Screw the pressure screw tightly onto the threaded sleeve.

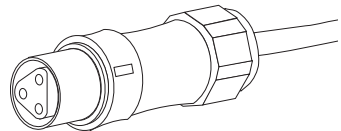

13. Tighten the safety ring to provide sealing and provide strain relief.

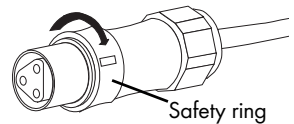

14. Close the socket element with the cap supplied in the accessories kit if the Sunny Boy is not being connected immediately.

15. Remove the protective cap of the flange plug on the Sunny Boy.

16. Connect the AC connection socket to the flange plug on the Sunny Boy.

17. Press the AC connection socket firmly against the flange plug until it audibly engages. Make sure the alignment of the AC connection socket is correct.

DANGER!
Lethal danger caused by high voltages in the Sunny Boy!

- Do not switch on the line circuit breaker until the solar generator has been connected and the Sunny Boy is securely closed.

5.3 Solar generator connection (DC)

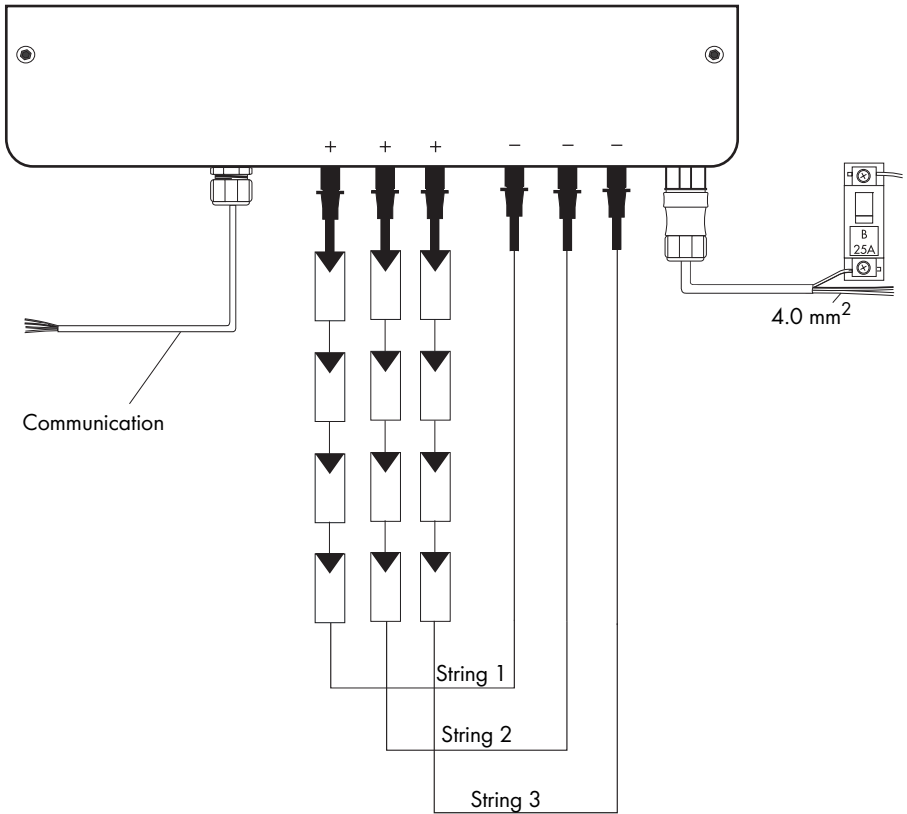

Connection procedure



DANGER!

Danger to life due to high voltages on the Sunny Boy

- Before connecting the PV generator, ensure that the line circuit breaker is switched off.

1. Remove the Electronic Solar Switch.

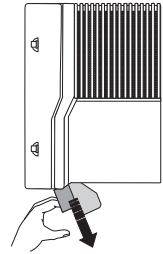

NOTICE!

Exceeding the maximum input voltage can destroy the Sunny Boy!

- Check the connection cables of the solar modules for correct polarity and that the maximum input voltage of the Sunny Boy is not exceeded.
- Do not connect strings with an open circuit voltage greater than the maximum input voltage of the Sunny Boy.
- Check the system design if the open circuit voltage of the solar modules is less than 10 % below the maximum input voltage of the Sunny Boy.

2. Check the strings for ground faults, as described in section 9.2 „Ground fault monitoring“ (35).

NOTICE!

High currents can damage the Sunny Boy!

- The maximum possible current per DC plug may not exceed 16 A.

3. Connect the DC plug connectors.
4. Close unused input sockets with the sealing caps included in the packing list.
5. Reinsert the Electronic Solar Switch in the socket.

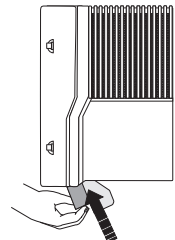

NOTICE!**The Electronic Solar Switch can be damaged if it is inserted incorrectly!**

- Do not tighten the screw inside the handle.
- Insert the handle of the Electronic Solar Switch securely in the socket on the underside of the housing.
- Check the handle of the Electronic Solar Switch is securely connected.

5.4 Communication

There are various types of communication interfaces. These communication interfaces are used to communicate with SMA communication devices or a PC with appropriate software.

See the communication device documentation for a detailed wiring diagram.

5.4.1 Line-conducted Communication

Connection procedure for line-conducted communication

NOTICE!**Electrostatic discharges can damage the communication interface!**

- Before unpacking the communication interface ground yourself by touching PE or a grounded object.

1. Open the Sunny Boy as described in section 7.1 „Opening the Sunny Boy“ (28).
2. Remove the sealing plugs from the housing feed-through.
3. Guide the PG screw fitting over the communication cable.
4. Guide the communication cable through the cable feed-through (A) of the Sunny Boy.
5. Screw the PG screw fitting onto the Sunny Boy.
6. Tighten the sealing ring of the PG screw fitting to ensure sealing and strain relief.
7. Sheathe the communication cable inside the Sunny Boy using the silicone tube included in the packing list.
8. Lay the cable in area (B). See the figure to the right.
9. Ground the communication cable at the PE connector (C) if the connection plan of the communication device indicates this as necessary.

NOTICE!**Connecting the receiver incorrectly can damage the devices!**

- Connect the communication cables to the screw terminal strip (D) as described in the connection plan of the communication device.

10. Note down the conductor color coding for the respective pin numbers.
 - Pin 2 color: _____
 - Pin 3 color: _____
 - Pin 5 color: _____
 - Pin 7 color: _____
11. Connect the jumpers (E) if the connection plan of the communication device indicates this as necessary. Details on the jumper functions can be found in the communication device documentation.
12. Plug the communication interface to the left of the board (F).
13. Close the Sunny Boy as described in section 7.2 „Closing the Sunny Boy“ (29).

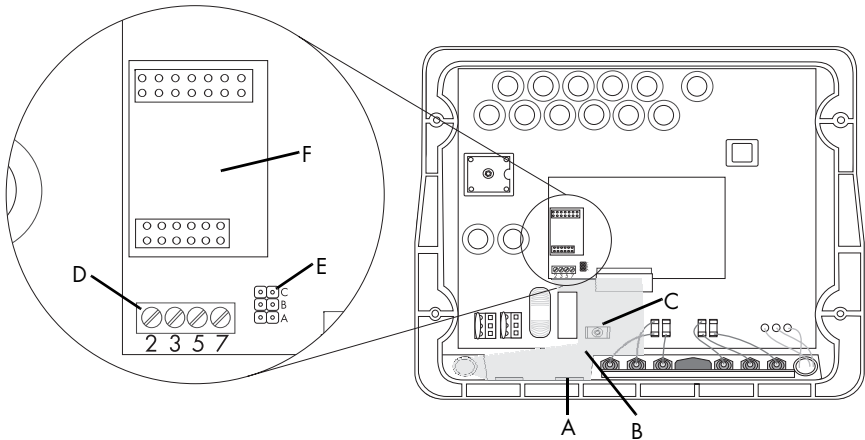

Object	Description
A	Housing feed-through with sealing plugs in the base of the Sunny Boy
B	Cable route (gray surface)
C	PE connector
D	Screw terminals for connection of the communication wires
E	Jumper slot
F	Interface port

5.4.2 Wireless Communication

Connection procedure for wireless communication

1. Open the Sunny Boy as described in section 7.1 „Opening the Sunny Boy“ (28).
2. Remove the sealing plugs from the housing feed-through.
3. Guide the antenna cable through the cable feed-through (A) of the Sunny Boy.
4. Screw the PG screw fitting onto the Sunny Boy.
5. Lay the cable in area (B). See the figure below.
6. Plug the communication interface to the left of the board (C).
7. Screw the antenna cable with the antenna connection to the interface as described in the communication documentation.
8. Close the Sunny Boy as described in section 7.2 „Closing the Sunny Boy“ (29).

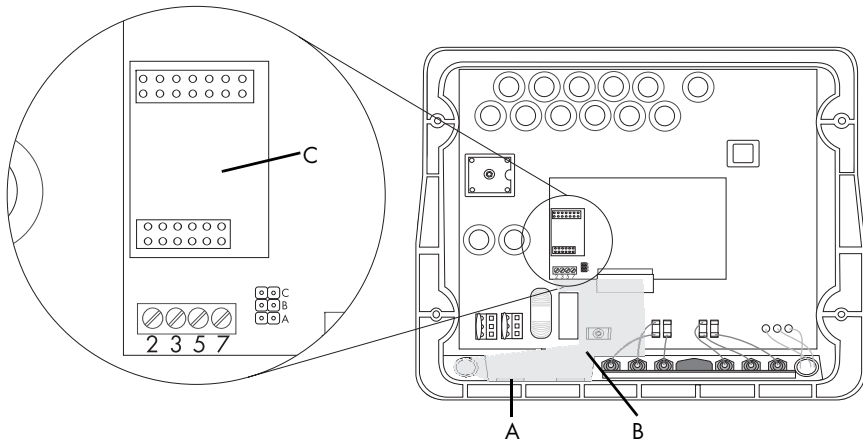

Object	Description
A	Housing feed-through with sealing plugs in the base of the Sunny Boy
B	Cable route (gray surface)
C	Interface port

6 Commissioning

Check the following requirements before commissioning:

- correct connection of the AC (grid) cable
- full connection of the DC cables (PV strings)
- unused DC plug connectors on the underside of the housing are sealed with caps
- the housing lid is securely screwed in place
- the Electronic Solar Switch is securely plugged
- the line circuit breaker is laid out correctly

Commissioning procedure

1. Switch on the line circuit breaker.
2. An illuminated or blinking green LED signals fault-free operation. If this is the case, commissioning was completed successfully.

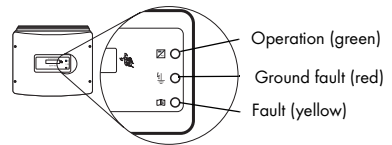

NOTICE!

Excessive DC input voltage can destroy the Sunny Boy!

- Disconnected the grid voltage and the PV generator if after a short time the bottom yellow LED flashes four times at intervals of one second and the display shows the message on the right.

!PV-Overvoltage!
!DISCONNECT DC!

6.1 Display Language and LED Display

6.1.1 Setting the Display Language

The display language of the display is set with the switches underneath the display assemblies inside the Sunny Boy.

You can change the language setting of the display as follows:

1. Open the Sunny Boy as described in section 7.1 „Opening the Sunny Boy“ (28).
2. Set the switch combination of the required language. See table.

Language	Switch S2	Switch S1
German	B	B
English	B	A
French	A	B
Spanish	A	A

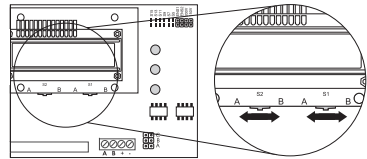

3. Close the Sunny Boy as described in section 7.2 „Closing the Sunny Boy“ (29).

6.1.2 LED Display

Overview

Green	Red	Yellow	Status
glows continuously	–	–	OK (feeding operation)
	glows continuously	–	Warning
		glows continuously	OK (initialization)
blinks quickly (3 x per second)	–	–	OK (stop)
	glows continuously	–	Warning
blinks slowly (1 x per second)	–	–	OK (waiting, grid monitoring)
	glows continuously	–	Warning
briefly goes out (approx. 1 x per second)	–	–	OK (derating)
	glows continuously	–	Warning
–	–	–	OK (night shutdown)
		–	Failure
		glows continuously	Failure
		glowing/blinking	Failure

For a detailed description of the failure messages and their causes, see the Sunny Boy user manual.

7 Opening and Closing

NOTICE!

Static discharges can damage the Sunny Boy!

- Before you touch a component inside the Sunny Boy ground yourself by touching PE or a grounded object.

7.1 Opening the Sunny Boy



DANGER!

Lethal danger caused by high voltages in the Sunny Boy!

Before you open the Sunny Boy:

- Switch off the line circuit breaker and secure it to prevent it from being reactivated.

1. Remove the Electronic Solar Switch.

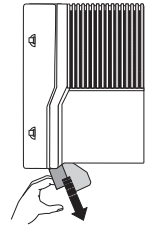

DANGER!

Danger to life due to unsafe disconnection from the PV-Generator!

Safe disconnection from the PV generator is only guaranteed after removal of the Electronic Solar Switch, **and** of all DC plug connectors.

- Remove the DC plug connector immediately to completely disconnect the PV generator from the Sunny Boy.

2. Check whether the LEDs and display have gone out.



DANGER!

Lethal danger caused by high voltages in the Sunny Boy!

- Wait 15 minutes for the capacitors to discharge.

3. Remove the screws from the housing cover and pull the cover forward smoothly.
4. Put the cover, screws and washers to one side so that they do not get lost.

7.2 Closing the Sunny Boy

1. Fasten the cover to the housing with four screws and washers, with the tooting facing toward the housing cover. The screws must be tightened with approximately 6 Nm torque to ensure the sealing of the housing and the grounding of the cover.
2. Connect the PV generator.
3. Check the Electronic Solar Switch for wear, as described in section 8.2 „Inspection of the Electronic Solar Switch“ (33).

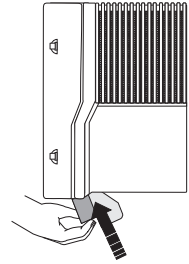

NOTICE!

The Electronic Solar Switch can be damaged if it is inserted incorrectly!

- Do not tighten the screw inside the handle.
- Insert the handle of the Electronic Solar Switch securely in the socket on the underside of the housing.
- Check the handle of the Electronic Solar Switch is securely connected.

4. Switch on the line circuit breaker or connect the AC plug.
5. Look at the LEDs or the display to check whether the Sunny Boy is in a fault-free operating status.

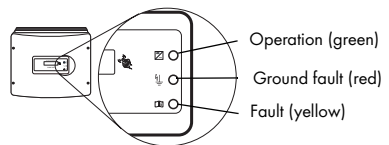

8 Maintenance and Cleaning

8.1 Checking Heat Dissipation

You only need to check the heat dissipation of the Sunny Boy if during a visual inspection you notice a marked build-up in the fan guard or the Sunny Boy is increasingly observed to be in derating mode. Whether the Sunny Boy switches to derating mode depends on the ambient temperature and cooling efficiency.

8.1.1 Cleaning the Fan

If the fan guard is only covered in loose dust it can be cleaned with a vacuum cleaner. If you do not achieve satisfactory results with a vacuum cleaner, you can dismantle the fan for cleaning.

If the fan guard is heavily soiled, proceed as follows:

1. Disconnect the Sunny Boy from both the DC and AC connections.
2. Wait for the fan to stop rotating.
3. Push the latches of the plastic cover to the right and remove the plastic cover carefully along with the fan guard fitted behind.
4. Clean the fan guard with a soft brush, a paint brush, a cloth or compressed air.

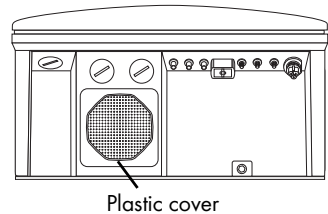

The fan behind the guard is attached to the housing of the Sunny Boy with three plastic clips. If this is also soiled clean it as follows:

5. Push the two upper plastic clips backward and the lower plastic clip forward.
6. Remove the fan by pulling it slowly and carefully downwards.
7. Unlock and unplug the fan plug inside the Sunny Boy.
8. Clean the fan with a soft brush, a paint brush, or a cloth. Under no circumstances should you use compressed air to clean the fan. This can damaged the fan.
9. After cleaning, assemble everything in reverse order.
10. Check that the fan is functional.

8.1.2 Cleaning the Fan Gills

There are fan gills on either side of the Sunny Boy. The Sunny Boy sucks air in from underneath via the fan and blows it out again on the left-hand side. For optimum heat dissipation within the device, all you have to do is clean the left-hand fan gill. Proceed as follows when cleaning the fan gill(s):

11. Place your finger in the space between the top of the housing and the fan gill. Gently pull the left fan gill out of its bracket.

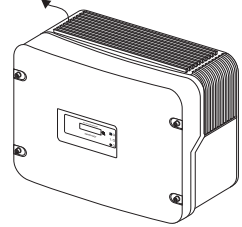

12. Clean the fan gills with a soft brush, a paint brush, or compressed air.
13. Reattach the fan gills to the Sunny Boy. To help you identify the sides, "links/left" or "rechts/right" is printed on the inside of the fan gills.

8.1.3 Testing the Fan

There are two ways to check the fan is functional:

- Set the "Fan Test" parameter to "1" in the installer mode (using Sunny Data, Sunny Data Control or the Sunny Boy Control data logger).
- Connect the jumper to the controller board (the jumper for checking the fans is included in the Sunny Boy accessories kit).

Setting the parameter

1. Request the installer password on the SMA Service Line (contact: see page 59).
2. Set the "Fan Test" parameter to "1" in the installer mode.
3. The Sunny Boy sucks air in from underneath and then blows it back out on the upper sides. Look out for any unusual noise which could indicate incorrect installation or that the fans are faulty.
4. After checking the fans, set the "Fan Test" parameter back to 0.

Setting the jumper

1. Open the Sunny Boy as described in section 7.1 „Opening the Sunny Boy“ (28).
2. Plug the jumper in the jumper slot on the controller board as shown below.

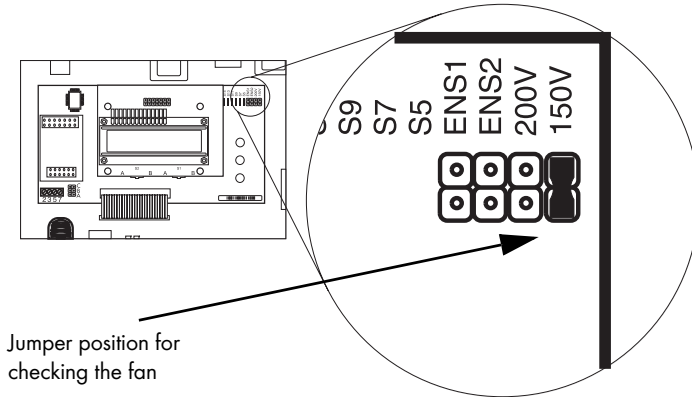

3. Close the Sunny Boy as described in section 7.2 „Closing the Sunny Boy“ (29).
4. Restart the Sunny Boy.
The jumper is only recognized after the system has been restarted (i.e. all LEDs must have gone out before a restart).
5. Check the fan's air-flow: the Sunny Boy sucks air in from underneath and then blows it back out on the upperleft-handside. Look out for any unusual noise which could indicate incorrect installation or that the fan is faulty.!
6. Remove the jumper. Open and close the Sunny Boy as described in section 7 „Opening and Closing“ (28).

8.2 Inspection of the Electronic Solar Switch

1. Check the Electronic Solar Switch for wear.
2. Check the metal tongues on the inside of the plug for brown discoloration.

Event	Measure
The metal tongues show brown discoloration.	The metal tongues is burned out (see figure below). The Electronic Solar Switch can no longer safely disconnect the DC side. Do not insert the handle again. Replacements for damaged Electronic Solar Switch handles are available from SMA Solar Technology.
The metal tongues do not show brown discoloration.	Insert the Electronic Solar Switch securely in the socket on the underside of the housing.

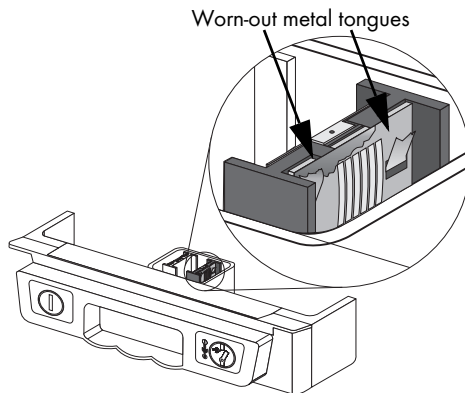

9 Troubleshooting

9.1 Checking the Varistors

Varistors are wearing parts. Their functional efficiency diminishes with age or following repeated responses as a result of overvoltages. If the red LED glows continuously, it is possible that one of the thermally monitored varistors has lost its protective function.

You can check these varistors in the following way:

1. Open the Sunny Boy as described in section 7.1 „Opening the Sunny Boy“ (28).
2. Use a multimeter to check all the varistors and see if there is a conducting connection between connectors 2 and 3.

Event	Measure
There is a conducting connection.	There is probably another fault in the Sunny Boy. Contact the SMA Service Line. Continue with point 4.
There is no conducting connection.	The respective varistor is defective and must be replaced. The varistors are specially manufactured for use in the Sunny Boy and are not commercially available. They must be ordered directly from SMA Solar Technology. To replace the part, proceed to step 3.

3. Replace all varistors with new ones as shown in this drawing. Varistor failure is generally due to influences which affect all varistors similarly (temperature, age, induced overvoltages). If you do not receive a special tool together with the replacement varistors, please contact SMA Solar Technology. As an alternative, the terminal contacts can be operated using a 3.5 mm wide screwdriver. Ensure the varistor is installed the right way round!

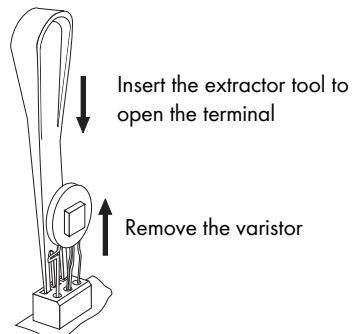

The pole with the small loop (crimp) must be fitted to terminal 1 when replacing the varistor

4. Close the Sunny Boy as described in section 7.2 „Closing the Sunny Boy“ (29).

9.2 Ground fault monitoring



DANGER!

Danger to life due to live PV generator!

- Do not touch the frame of the solar generator.
- Do not touch PE.
- Do not connect strings with ground faults to the Sunny Boy.
- Wait until there is no voltage measurement.

1. Open the Sunny Boy as described in section 7.1 „Opening the Sunny Boy“ (28).
2. Measure the voltages between the plus and minus pole of a string against the ground potential. If a voltage is present, there is a ground fault in the corresponding string.

The approximate position of the ground fault can be determined from the ratio of the measured voltages between plus against ground potential and minus against ground potential.

For example:

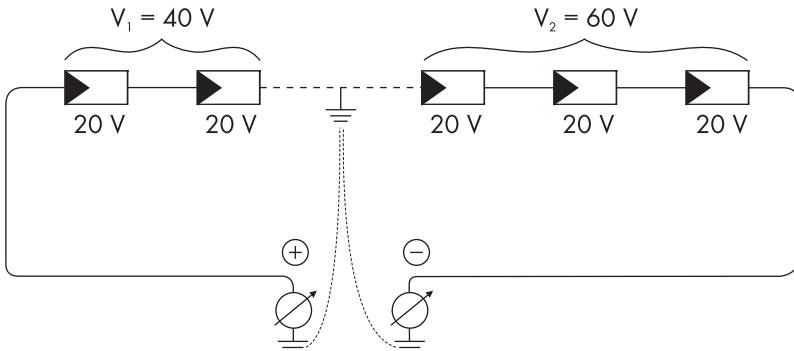

The ground fault is between the second and third module in this case.

3. Repeat point 2 for each string.
4. Close the Sunny Boy as described in section 7.2 „Closing the Sunny Boy“ (29).

10 Decommissioning

10.1 Disassembly



CAUTION!

Risk of injury due to the heavy weight of the Sunny Boy!

- Take the Sunny Boys weight of 41 kg into account.



DANGER!

Lethal danger caused by high voltages in the Sunny Boy!

- Switch off the line circuit breaker and secure it to prevent it from being reactivated.
- Remove the AC connection socket from the Sunny Boy.

1. Close the AC flange plug with the protective cap.



DANGER!

Danger to life due to unsafe disconnection from the solar generator!

- Remove the Electronic Solar Switch handle.
- Disconnect all the DC plug connectors.

2. Close the DC input sockets with the sealing caps included in the packing list.



CAUTION!

Danger of burn injuries due to hot housing parts!

The Sunny Boy housing can become hot during operation.

- Wait until the housing has cooled down.

3. If there is a communication cable, continue with point 7. If there is no communication cable, continue with point 10.
4. Open the Sunny Boy as described in section 7.1 „Opening the Sunny Boy“ (28).
5. Remove the communication cable from the Sunny Boy.
6. Close the Sunny Boy as described in section 7.2 „Closing the Sunny Boy“ (29).

NOTICE!

The Electronic Solar Switch can be damaged if it is inserted incorrectly!

- Do not tighten the screw inside the handle.
- Insert the handle of the Electronic Solar Switch securely in the socket on the underside of the housing.
- Check the handle of the Electronic Solar Switch is securely connected.

7. Remove the securing screw.
8. Remove the Sunny Boy from the rear panel.

10.2 Packaging

If possible, please pack the Sunny Boy in the original packaging. If this is no longer available, you can also use an equivalent box that fulfills the following requirements:

- suitable for loads up to 41 kg
- with handle system
- can be closed fully

10.3 Storage

Store the Sunny Boy in a dry place where the ambient temperatures are always between -25 °C and +60 °C.

10.4 Disposal

Dispose of the Sunny Boy at the end of its service life in accordance with the disposal regulations for electronic waste which apply at the installation site at that time. Alternatively, send it back to SMA Solar Technology with shipping paid by sender, and labeled "ZUR ENTSORGUNG" ("for disposal").

11 Technical Data

PV-Generator connection data		Sunny Boy 3300	Sunny Boy 3800
Max. input power	P_{DC}	3820 W	4040 W
Max. input voltage	U_{PV0}	500 V ^{a)}	
Input voltage, MPP range	U_{PV}	200 V - 400 V	
Max. input current	$I_{PV, max}$	20 A	
Max. current per DC plug		16 A	
Number of MPP trackers		1	
Max. no. of strings (parallel)		3	
Operating internal consumption		< 7 W	

a) The maximum open circuit voltage, which can occur at a cell temperature of -10 °C, may not exceed the maximum input voltage.

Grid connection data		Sunny Boy 3300	Sunny Boy 3800
Nominal output power	$P_{AC, nom}$	3300 W	3800 W
Max. nominal output power	$P_{AC, max}$	3600 W	3800 W
Max. output current	$I_{AC, max}$	18 A	
Max. allowed fuse protection		25 A	
Harmonic distortion of output current (at $T_{HD} < 2\%$, $P_{AC} > 0.5 P_{ACnom}$)	K_{IAC}	< 3 %	
Nominal AC voltage / range	U_{AC}	220 V - 240 V / 180 V - 260 V	
AC grid frequency (self-adjusting) operating range	f_{AC}	50 Hz / 60 Hz / ± 4.5 Hz	
Overvoltage category		III	
Test voltage (50 Hz)		1.4 kV	
Test surge voltage		4 kV (serial interface: 6 kV)	
Power factor (at nominal output power)	cos Phi	1	
AC connection		single-phase	
Internal consumption at night		< 0.1 W	

General data		Sunny Boy 3300	Sunny Boy 3800
EC Declaration of Conformity		enclosed set of documents, download area at www.SMA.de/en under Certificate	
Dimensions (W / H / D) in mm		450 / 352 / 236	
Weight		41 kg	
Protection rating in accordance with DIN EN 60529		IP65	

General data	Sunny Boy 3300	Sunny Boy 3800
Climatic conditions in accordance with DIN EN 60529:		
Location of type C:	Class 4K4H extended temperature range: -25 °C to +60 °C extended air humidity range: 0 ... 100 % extended air pressure range: 79.5 kPa to 106 kPa	
Transport of type E:	Class 2K3 Temperature range: -25 °C to +70 °C	
Operation temperature range	-25 °C to +60 °C	
Max. operating altitude	2000 m above sea level	
Topology	Low frequency transformer	
Cooling concept	OptiCool	
Fan connections	designed for safe disconnection according to DIN EN 50178:1998-04	

Protective function DC side

All-pole disconnection unit on the DC side	Electronic Solar Switch, DC plug connector
Overvoltage protection	thermally monitored varistors
Personal protection	Insulation monitoring (Riso > 1 MOhm)
Reverse polarity protection	via short-circuit diode

Protective function AC side

Short-circuit proofing	Current control
All-pole disconnection unit on grid side	Automatic disconnection device (SMA grid guard 2)

Efficiency	Sunny Boy 3300	Sunny Boy 3800
Max. efficiency η_{\max}	95,2 %	95,6 %
Euro ETA η_{euro}	94,4 %	94,7 %

Efficiency curves

The efficiency of the Sunny Boy depends mainly on the input voltage of the connected PV strings. The lower the input voltage, the higher the efficiency.

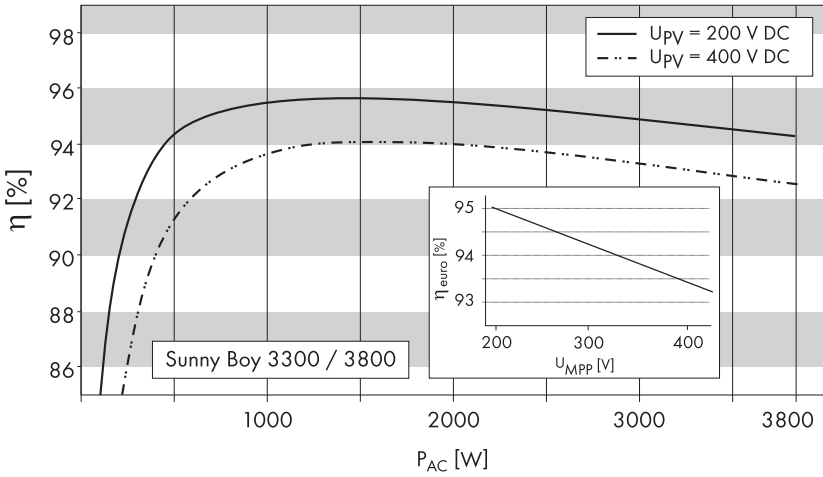

12 Contact

If you have technical problems concerning our products, please contact the SMA Service Line. We require the following information in order to provide you with the necessary assistance:

- Sunny Boy device type
- serial number of the Sunny Boy
- type and number of modules connected
- blink code or display of the Sunny Boy
- type of communication, if applicable

SMA Solar Technology AG

Sonnenallee 1

34266 Niestetal, Germany

Tel. +49 561 9522499

Fax +49 561 95224699

ServiceLine@SMA.de

www.SMA.de

The information contained in this document is the property of SMA Solar Technology AG. Publishing its content, either partially or in full, requires the written permission of SMA Solar Technology AG. Any internal company copying of the document for the purposes of evaluating the product or its correct implementation is allowed and does not require permission.

Exclusion of liability

The general terms and conditions of delivery of SMA Solar Technology AG shall apply.

The content of these documents is continually checked and amended, where necessary. However, discrepancies cannot be excluded. No guarantee is made for the completeness of these documents. The latest version is available online at www.SMA.de or from the usual sales channels.

Guarantee or liability claims for damages of any kind are excluded if they are caused by one or more of the following:

- Damages during transportation
- Improper or inappropriate use of the product
- Operating the product in an unintended environment
- Operating the product whilst ignoring relevant, statutory safety regulations in the deployment location
- Ignoring safety warnings and instructions contained in all documents relevant to the product
- Operating the product under incorrect safety or protection conditions
- Altering the product or supplied software without authority
- The product malfunctions due to operating attached or neighboring devices beyond statutory limit values
- In case of unforeseen calamity or force majeure

The use of supplied software produced by SMA Solar Technology AG is subject to the following conditions:

- SMA Solar Technology AG rejects any liability for direct or indirect damages arising from the use of software developed by SMA Solar Technology AG. This also applies to the provision or non-provision of support activities.
- Supplied software not developed by SMA Solar Technology AG is subject to the respective licensing and liability agreements of the manufacturer.

SMA Factory Warranty

The current guarantee conditions come enclosed with your device. These are also available online at www.SMA.de and can be downloaded or are available on paper from the usual sales channels if required.

Trademarks

All trademarks are recognized even if these are not marked separately. Missing designations do not mean that a product or brand is not a registered trademark.

SMA Solar Technology AG

Sonnenallee 1

34266 Niestetal

Germany

Tel. +49 561 9522-0

Fax +49 561 9522-100

www.SMA.de

E-Mail: info@SMA.de

© 2004 to 2008 SMA Solar Technology AG. All rights reserved

SMA Solar Technology AG

www.SMA.de

Sonnenallee 1

34266 Niestetal, Germany

Tel.: +49 561 9522 4000

Fax: +49 561 9522 4040

E-Mail: Vertrieb@SMA.de

Freecall: 0800 SUNNYBOY

Freecall: 0800 78669269

