

SMA Bluetooth® Wireless Technology

Technical Description

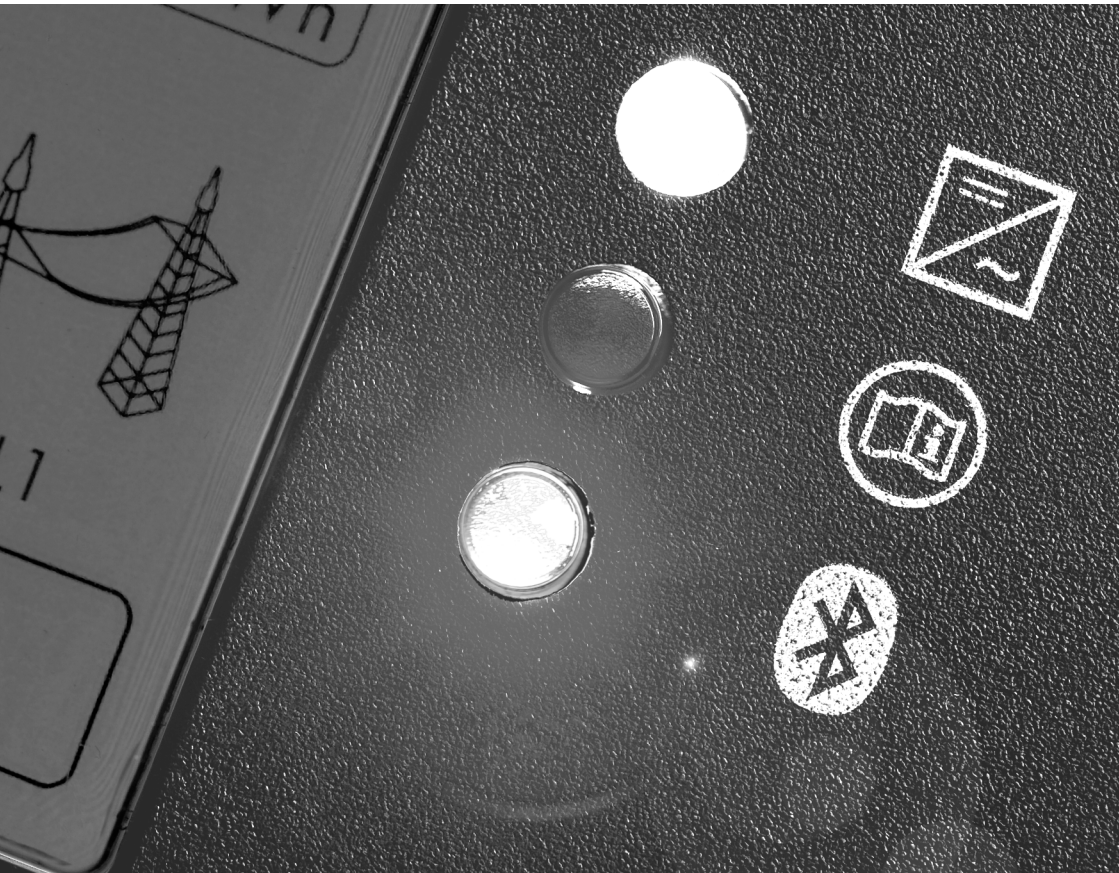

Table of Contents

| | | |
|----------|---|-----------|
| 1 | Notes on this Document. | 5 |
| 1.1 | Target Group | 5 |
| 1.2 | Symbols Used | 5 |
| 2 | Short introduction. | 6 |
| 2.1 | What is <i>Bluetooth</i> Wireless Technology? | 6 |
| 2.2 | Why <i>Bluetooth</i> Wireless Technology? | 7 |
| 3 | SMA Bluetooth | 8 |
| 3.1 | SMA <i>Bluetooth</i> Devices | 8 |
| 3.2 | Special features of SMA <i>Bluetooth</i> | 8 |
| 3.3 | NetID | 10 |
| 3.4 | Number of participants in a <i>Bluetooth</i> network | 11 |
| 3.5 | Setup of a <i>Bluetooth</i> network | 12 |
| 3.6 | Master and Slaves in the <i>Bluetooth</i> Network | 13 |
| 4 | Basics for the Planning of a Bluetooth PV System | 16 |
| 4.1 | Range of radio signals | 16 |
| 4.1.1 | Damping Obstacles | 16 |
| 4.1.2 | Penetration of Obstacles | 17 |
| 4.1.3 | Strength of Damping by Obstacles | 18 |
| 4.1.4 | Changing Conditions | 20 |
| 4.1.5 | Radio Signal Reflections | 20 |
| 4.1.6 | Transmitting Power of Devices. | 20 |
| 4.1.7 | Receiver Sensitivity of Devices. | 21 |
| 4.2 | Notes on Installation Site | 21 |
| 4.2.1 | Use of the SMA <i>Bluetooth</i> Repeater | 22 |
| 4.3 | Diagnostics Facility | 23 |
| 5 | Commissioning of a Bluetooth PV System | 24 |
| 5.1 | Procedure | 24 |





| | | |
|----------|---|-----------|
| 5.1.1 | Commissioning a New <i>Bluetooth</i> PV System | 24 |
| 5.1.2 | Adding Devices to Existing <i>Bluetooth</i> PV Systems. | 25 |
| 5.2 | Determining a Free NetID. | 26 |
| 5.3 | Check radio connection | 29 |
| 5.3.1 | Inverters with integrated SMA <i>Bluetooth</i> | 29 |
| 5.3.2 | SMA <i>Bluetooth</i> Repeater | 30 |
| 5.3.3 | Communication device | 31 |
| 6 | FAQ | 32 |
| 7 | Glossary | 34 |

1 Notes on this Document

1.1 Target Group

This document is aimed towards all those who would like to receive information on *Bluetooth* in devices from SMA Solar Technology.

1.2 Symbols Used

| Symbol | Description | |
|---|--|--------|
|  | The radio symbol shows that a device has a <i>Bluetooth</i> connection to another <i>Bluetooth</i> device. | |
|  | Inverter with <i>Bluetooth</i> from SMA Solar Technology (Example: Sunny Boy 3000TL-20 / 4000TL-20 / 5000TL-20) | Slave |
|  | SMA <i>Bluetooth</i> Repeater | Slave |
|  | Communication device with <i>Bluetooth</i> from SMA Solar Technology (Example: Sunny Beam with <i>Bluetooth</i>) | Master |
|  | Computer with <i>Bluetooth</i> and Sunny Explorer software (Example: laptop) | Master |



Note

Note indicates important information

2 Short introduction

2.1 What is *Bluetooth* Wireless Technology?

Bluetooth is a radio standard for short-range communication which enables a connection to be made between devices having *Bluetooth*. Unlike infra-red connections, *Bluetooth* connections do not need the devices to be aligned directly next to each other and do not necessarily need a direct visual contact.

Bluetooth is installed for example in computer keyboards and mobile devices such as PDAs (Personal Digital Assistants) and mobile telephones, in order to transmit and receive data to and from a computer. *Bluetooth* was developed in order to reduce the number of cable connections between devices.

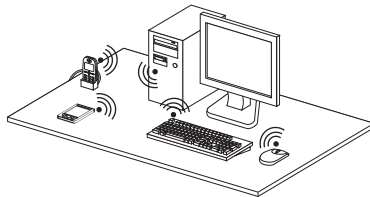

The radio range of standard devices with *Bluetooth* Wireless Technology is around 10 m (*Bluetooth* Class 2). This radio range is completely sufficient for devices with connections between mobile telephones and headsets. For applications which require larger radio ranges, there is the *Bluetooth* Class 1 with a radio range of up to 100 m.

2.2 Why *Bluetooth* Wireless Technology?

Bluetooth is already integrated into many multimedia devices (e.g. laptops) and is used for the exchange of data between devices. Properties of *Bluetooth*:

- wireless and therefore easy to install. The installation of cables is not necessary.
- Approved world wide (public domain 2.4 GHz frequency band).
End users do not have to register *Bluetooth*.
- free of charge, independent of the transmitted data volumes.
- fail-safe

With AFH (Adaptive Frequency Hopping) there is continuous switching between the 79 *Bluetooth* channels in random order and frequencies disturbed by WLAN routers, for example, or those already occupied are ignored. Through AFH and a narrowband transmission technology *Bluetooth* is rarely interfered with by other devices and interferes with other devices rarely.

- good radio range with *Bluetooth* Class 1

Bluetooth Class 1 has a radio range in open air of up to 100 m with a low transmitting power. The transmitting power is a maximum of 100 mW and reduces automatically, as soon as a good connection is available. As a result unnecessarily high transmitting powers are avoided.

- easy to upgrade

Computers can be easily upgraded with *Bluetooth* via USB *Bluetooth* sticks.

3 SMA Bluetooth

3.1 SMA Bluetooth Devices

SMA Solar Technology offers devices with *Bluetooth* for your PV system. With these you can monitor your PV system without the need for additional cabling for communication between devices.

SMA Solar Technology offers inverters with *Bluetooth*, communication devices with *Bluetooth* and Sunny Explorer software for your computer with *Bluetooth*. Gaps in the *Bluetooth* network can be bridged by the SMA *Bluetooth* Repeater.

3.2 Special features of SMA Bluetooth

- Automatic setup of a *Bluetooth* network

The devices with SMA *Bluetooth* connect themselves to a *Bluetooth* network. Each device connects automatically to a device that is in radio range and has the best connection quality.

For example, when one sets up a connection to an inverter that is in radio range using the Sunny Beam with *Bluetooth*, one is connected with the entire *Bluetooth* network. As a result, one can receive data from inverters which lie outside the direct radio range of the Sunny Beam with *Bluetooth*.

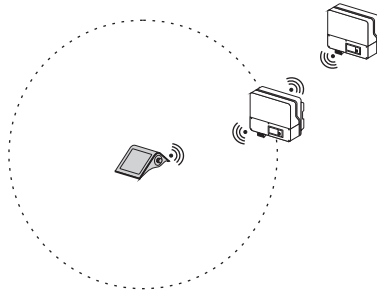

The layout of the *Bluetooth* network is flexible; the order in which the devices form the network is not specified to the devices. The layout of the *Bluetooth* network is therefore flexible and less prone to interference.

- Up to 50 devices in a *Bluetooth* network:
 - Inverter
 - *SMA Bluetooth Repeater*
- Up to 4 Masters simultaneously in one *Bluetooth* network (for 3 slaves, see page 13):
 - Communication Devices
 - Computers with *Bluetooth* and Sunny Explorer software from SMA Solar Technology.
- Automatic reorganization of the *Bluetooth* network in the event of inclusion or removal of devices, if for example the connections to these devices were interrupted.
- Up to 100 m radio range in open air with direct visual contact (*Bluetooth Class 1*).
Due to the inverter housing, the *SMA Bluetooth Piggy-Back* - with which inverters can be retrofitted with *SMA Bluetooth* - only reaches a radio range of up to 50 m in open air with direct visual contact.
- Increase of the range by expanding the *Bluetooth* network through additional devices.
- Differentiation between other PV systems with *SMA Bluetooth* in the neighborhood through 14 different NetIDs.
- Security of the PV system via a system password.

3.3 NetID

The NetID serves to differentiate between PV systems with SMA *Bluetooth* which are to be found in the direct neighborhood. The *Bluetooth* devices from SMA Solar Technology recognize their affiliation to the *Bluetooth* network of your PV system via a NetID.

The NetID can be a number between 1 to 9 or a letter from A to F.

16 NetIDs

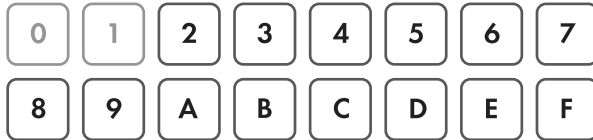

Bluetooth is switched off with a NetID of 0. Only devices with the same NetID (apart from NetID 1 and 0) can connect to a *Bluetooth* network. The devices of a complete *Bluetooth* network thus always have the same NetID. Therefore you can prevent your devices connecting to a PV system in the neighborhood which also uses *Bluetooth* from SMA Solar Technology.

Setting the NetID for the inverter and the SMA *Bluetooth* Repeater

For the inverters and the SMA *Bluetooth* Repeater the NetID is set using rotary switches on the device. The newly set NetID is immediately active in an operational device.

Communication products take on the NetID of the *Bluetooth* PV system

During commissioning, the communication products search in the first case for *Bluetooth* PV systems from SMA Solar Technology which are within their range. The NetIDs of the *Bluetooth* PV systems found are registered. Once you have selected the NetID of your system, the communication product takes on the selected NetID and sets up a connection to your *Bluetooth* PV system.

Functions of the NetID

The following table shows the functions of the NetIDs. NetID 0 and NetID 1 have special functions. NetID 1 is pre-installed in the inverters with SMA *Bluetooth* and the SMA *Bluetooth* Repeater for shipping.

| NetID | Function |
|--------------------------------|---|
| 0 | <i>Bluetooth</i> is switched off. |
| 1 (Condition upon delivery) | <p><i>Bluetooth</i> is switched on.</p> <p>The device can not set up a connection with other inverters or to SMA <i>Bluetooth</i> Repeaters.</p> <p>The device (inverter, SMA <i>Bluetooth</i> Repeater) can only accept a maximum of 2 connections to computers with <i>Bluetooth</i> and Sunny Explorer software from SMA Solar Technology. A connection to Sunny Beam with <i>Bluetooth</i> is not possible.</p> |
| 2 - F | <p><i>Bluetooth</i> is switched on.</p> <p>The device (inverter, SMA <i>Bluetooth</i> Repeater) can be network with all SMA <i>Bluetooth</i> products with the same NetID.</p> |

3.4 Number of participants in a *Bluetooth* network

Up to 50 devices with the same NetID can participate in an SMA *Bluetooth* network. These devices include inverters and SMA *Bluetooth* Repeaters. If you want to network more than 50 devices, you must divide you PV system into several *Bluetooth* networks, to which you assign different NetIDs.

If your *Bluetooth* network is made up of 90 devices, you can assign NetID 3 to 45 devices, for example, and NetID 4 to the remaining 45 devices.

It is better to divide a PV with 90 devices into two similar sized *Bluetooth* networks (not 60 and 30 devices, rather 45 and 45 devices) because the network set up and communication is faster if there are fewer devices assigned to one NetID.

3.5 Setup of a *Bluetooth* network

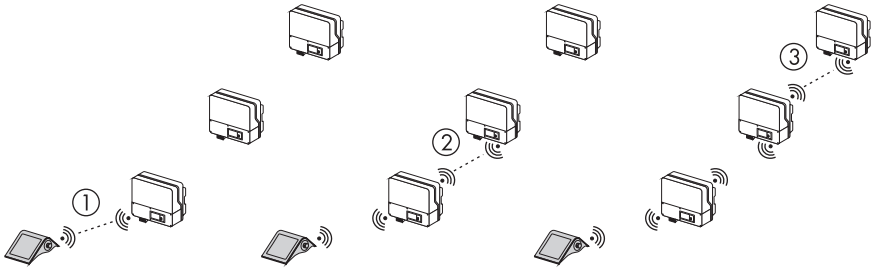

- 1 The communication device firstly sets up a connection to a participant of the *Bluetooth* network which is to be found within range. This participant is the root node.
- 2 From this participant outwards, the communication device realizes the setup of the *Bluetooth* network of all devices with the same NetID.
- 3 The devices connect themselves amongst each other in a self arranged manner; each device connects to a device which has the best connection quality. Depending on the size of the *Bluetooth* network, this procedure can take anything between a few seconds up to several minutes.

Only the communication devices can initiate the procedure in which all devices with the same NetID network themselves. The inverters do not set up a *Bluetooth* network without a communication device.

Self-organized rebuild of the *Bluetooth* network

If individual participants are separated from the *Bluetooth* network (e.g. due to a disturbance in the radio connection), the *Bluetooth* network rebuilds itself with the remaining participants. If a new participant with the same NetID is added to the *Bluetooth* network, it is automatically integrated into the *Bluetooth* network. If participants are added to or fall out of the *Bluetooth* network, the communication devices are informed.

Root node in the *Bluetooth* network

The root node is the device which directly connects to a Master and initiates the setup of the complete *Bluetooth* network. The root node can be a different device for each rebuilding of the *Bluetooth* network. It is always the device via which a Master initiates the setup of the complete *Bluetooth* network that becomes the root node - that is to say the device which the Master connects to directly. If the Master is a mobile device such as the Sunny Beam with *Bluetooth* or a laptop with *Bluetooth* together with Sunny Explorer software, then every Slave within the *Bluetooth* network can become the root node, depending upon which Slave is to be found within *Bluetooth* range.

A Master device with SMA *Bluetooth* always connects to the device to which it has the best connection quality. If the Master is a computer with *Bluetooth* and Sunny Explorer software from SMA Solar Technology, the computer connects itself via its integrated *Bluetooth* interface or via a USB *Bluetooth* stick to a device randomly. Most often, this is the first device found, irrespective of the connection quality.

During the system registration, Sunny Explorer offers you the possibility of selecting the root node. The device which is closest to the computer should be selected for the connection setup.

3.6 Master and Slaves in the *Bluetooth* Network

Master and Slave are terms from networking technology. In a network, a Master is a device that, for example, requests other devices (Slaves) to receive or transmit data.

In a *Bluetooth* network from SMA Solar Technology, the following products are Master and Slaves.

| Role | Products | Properties |
|--------|---|--|
| Master | <ul style="list-style-type: none"> • Communication products: <ul style="list-style-type: none"> - Sunny Beam with <i>Bluetooth</i> - Sunny Explorer (Software for the computer) | <ul style="list-style-type: none"> • Initiate the setup of the <i>Bluetooth</i> network. • Requests data. • Sends data to Slaves. |
| Slave | <ul style="list-style-type: none"> • Inverter • SMA <i>Bluetooth</i> Repeater | <ul style="list-style-type: none"> • Implements the requests and inputs of the Master. |



The Master devices are colored gray in the diagrams of this document.

Number of Masters in a *Bluetooth* network

In a *Bluetooth* network from SMA Solar Technology, several Masters can participate in the *Bluetooth* network at the same time. Therefore an installer can, for example, connect to the *Bluetooth* network via a laptop with *Bluetooth*, without the system owner having to disconnect his communication device from the *Bluetooth* network.

Up to 4 Masters can participate in a *Bluetooth* network at the same time: however, the number of Masters is dependent upon the number of Slaves.

2 Masters can connect to the Slave which forms the root node (A).



Every other slave can only accept a connection with 1 Master.

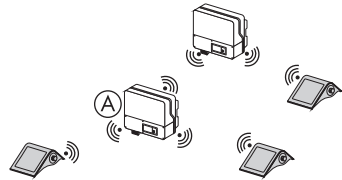

In order to be able to have the maximum number of 4 Masters participating in the *Bluetooth* network at the same time, a minimum of 3 Slaves are therefore necessary.

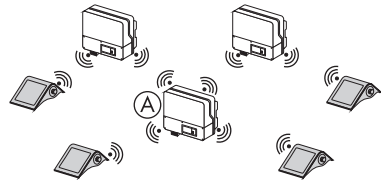

Uplinks and Downlinks in a *Bluetooth* Network

Uplink and Downlink are terms which declare the direction of transmission from Master to Slave in a network. Uplinks are connections in the direction of a Slave. The connection in the direction of a Master is identified as a Downlink.

In a standard *Bluetooth* network, a device can produce up to 7 connections at the same time. In a *Bluetooth* network from SMA Solar Technology, the 7 connections are separated into 5 Uplinks and 2 Downlinks, as this diagram shows for illustrative purposes.

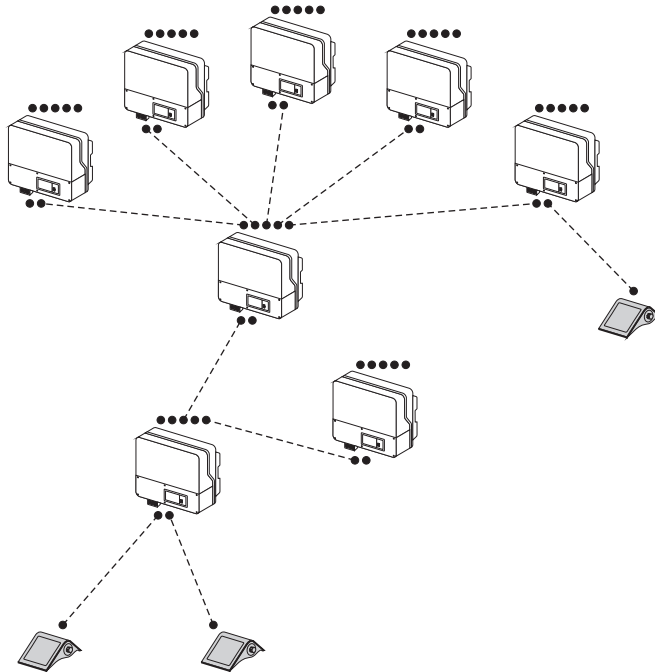

Master devices in an SMA *Bluetooth* network have only 1 Uplink, they can only connect directly to 1 device.

4 Basics for the Planning of a *Bluetooth* PV System

During the planning of a PV system with *Bluetooth* Wireless Technology it is useful to know the basics of data transmission via radio signals.

4.1 Range of radio signals

The maximum distance which radio signals can cover from one device to another is known as the range. Radio signals are strong at the start of the journey and continually weaken over distance due to diffusion.

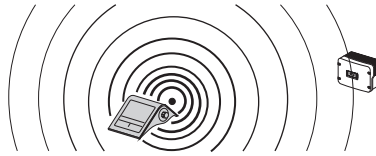

If no radio signals arrive at the other device or if the radio signals are too greatly weakened to be able to be received, then no radio connection between the devices is established.

The range of the radio signals depends on many influencing factors, which are partly manipulable. Influencing factors are for example the transmitting power and receiver sensitivity of the devices as well as damping objects which the radio signals have to penetrate.

4.1.1 Damping Obstacles

Since the devices do not often stand in direct visual range of each other, the radio signals must penetrate ceilings, walls and doors, for example. As a result of these obstacles the radio signals are weakened to various extents (damped). How greatly an obstacle damps the radio signals depends on the thickness and material of the obstacle.

The number of obstacles that have to be penetrated is likewise decisive. If the radio signals have to penetrate 2 walls, for example, then both walls damp the radio signals.

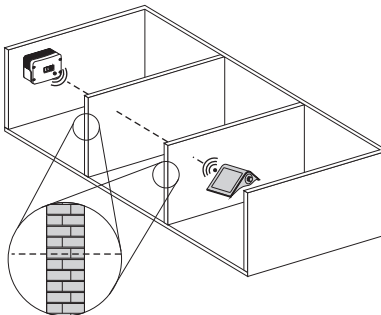

4.1.2 Penetration of Obstacles

The longer the distance is that the radio waves have to cover while penetrating an obstacle, the more the radio signal will be weakened by the obstacle.

The length of the distance is dependent on the thickness of the obstacle and whether the obstacle has to be penetrated perpendicularly or at an angle. The thicker an obstacle is, the longer the distance that the radio signals have to cover is during penetration of the obstacle.

Perpendicular penetration

If the radio signal can penetrate a wall perpendicularly, for example, then the distance through the wall is shorter and therefore the damping of the radio signals is lower.

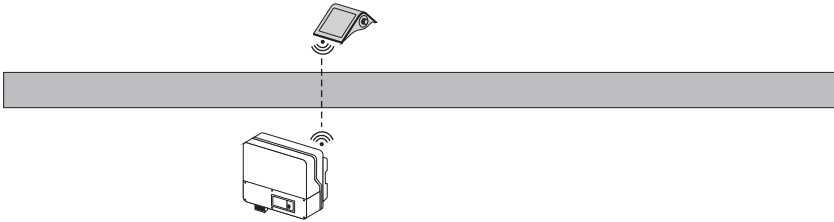

Penetration at an angle

If the radio signal has to penetrate a wall at an angle in order to reach from one device to another, then the distance through the wall is further and therefore the damping is greater than with radio signals that penetrate a wall perpendicularly.

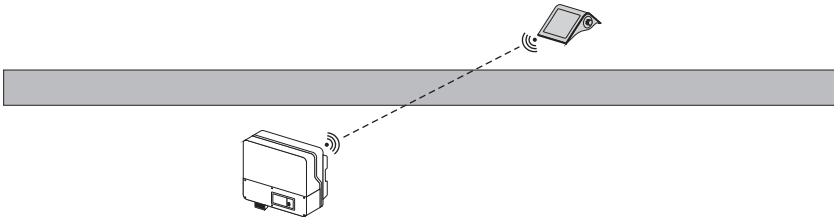

4.1.3 Strength of Damping by Obstacles

The following table should give you a rough indication of the strength of damping of various obstacles. With the help of the stated points you can, for example during system planning, roughly estimate how the obstacles in the transmission path have an effect on the quality of the *Bluetooth* network.

Even the best estimations can not take into consideration all of the various environmental conditions. Planted areas, floor coverings or fixtures and fittings can have unforeseeable positive or negative influences on the radio conditions.

| Obstacle | strength of damping in points |
|---|--------------------------------------|
| dry wooden door | 1 |
| double-glazed window | 10 |
| reinforced concrete 16 cm | 3 |
| vertically perforated brick 24 cm / 36.5 cm | 3 / 4 |
| porous concrete 17.5 cm / 36.5 cm | 3 / 5 |
| lightweight concrete wall 30 cm | 5 |
| sheet metal wall | 20 |
| Earth 50 cm | 20 |

If more than one obstacle has to be penetrated by the radio signals, then you must add the points of the obstacles together. As a result you will have a number of points, which enables you to make a rough estimation, with the help of the following table, how the obstacles will have an effect on the *Bluetooth* network.

| Points | Effect on the <i>Bluetooth</i> Network |
|---------------|---|
| up to 10 | Low negative influence. Stable operation with high data throughput. |
| 11 to 20 | Negative influence. Unstable operation with low data throughput. |
| more than 20 | Strongly negative influence. Unstable operation with very low to no data throughput. |

It can be helpful during the system planning stage to make a sketch of the installation site in order to be able to roughly estimate which radio conditions are to be expected due to the obstacles. With this you can establish a suitable installation site for the devices and include an SMA Bluetooth Repeater when necessary.

Example of obstacles at the installation site.

In this example, the radio signals from the inverters to the communication device have to penetrate 2 floors and 1 door. The damping effect is dependent on the material and the thickness of the floors.

Illustrative calculation for a rough estimate of the radio conditions:

The floor is made of 16 cm thick reinforced concrete, the door is made of wood. According to the table on page 18 this results in the following calculation:

2 x reinforced concrete (16 cm) each with 3 points = 6 points

1 x wooden door with 1 point = 1 point

Result: 7 points

Due to the 2 floors and the door, a low negative influence can be expected.

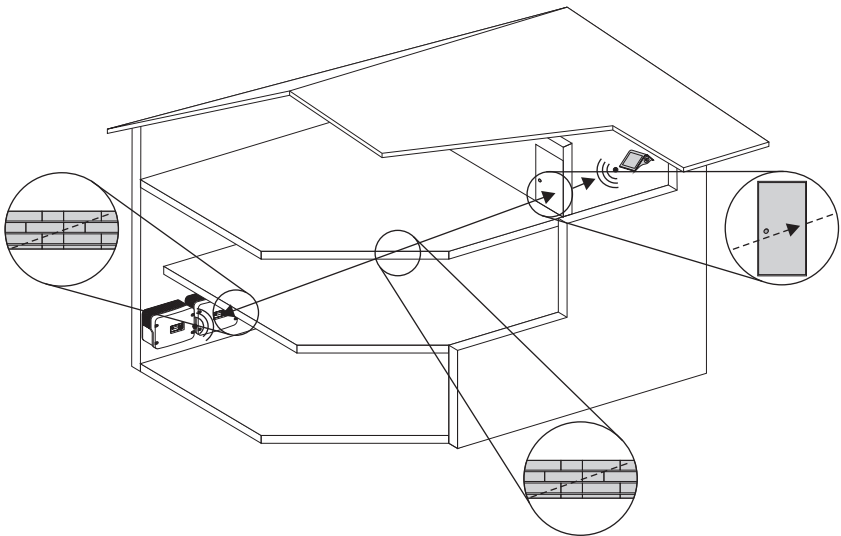

4.1.4 Changing Conditions

Changes which can occur during the operation of a *Bluetooth* network, such as the opening or closing of doors or windows or cars being parked, should be taken into consideration during the planning of a PV system with *Bluetooth*. All doors and windows should be closed during a test of the connection quality in order to simulate the worst-case conditions.



Even small changes in the local conditions can have large effects on the radio connection quality, especially in the case of weak connections.

4.1.5 Radio Signal Reflections

Reflections are dispersions of radio signals by other sources. For example, metal surfaces act like a mirror on radio signals. When radio signals hit a metal surface, they are reflected off of the metal surface at the same angle as that which they hit the metal surface (angle of irradiation = angle of radiation).

Depending on the local conditions, reflections can lead to the receiving conditions appearing to be better than would be assumed by a pure consideration of the damping effects. This can only be ascertained by an on site test.

4.1.6 Transmitting Power of Devices

The greater the transmitting power of a device, the stronger the radio signals that a device transmits are. The stronger the radio signals, the greater the range of the radio signals is. *Bluetooth* from SMA Solar Technology utilizes *Bluetooth* Class 1 and has a good radio range with a low transmitting power, which amounts to a maximum of 100 mW.

The transmitting power reduces automatically, as soon as a good *Bluetooth* connection is available. As a result unnecessarily high transmitting powers are avoided.

| Class | Transmitting Power | Radio Range in Open Air |
|-------|--------------------|-------------------------|
| 1 | 100 mW, 20 dBm | ~ 100 m |
| 2 | 2.5 mW, 4 dBm | ~ 10 m |
| 3 | 1 mW, 0 dBm | ~ 1 m |

The transmitting power of devices do not add together. The radio range between 2 *Bluetooth* participants is always only as large as the radio range of the participant with the lower transmitting power. Therefore the radio range of an inverter with Class 1 (up to 100 m radio range in open air with direct visual contact) to another inverter is greater than that of an inverter to a laptop with Class 2 (up to 10 m radio in open air with direct visual contact).



Tip

Laptops with *Bluetooth* Class 2 can be upgraded cheaply with a Class 1 USB *Bluetooth* stick.

4.1.7 Receiver Sensitivity of Devices

The receiver sensitivity is a measure of the minimum strength the radio signals have to have in order that they can be received without errors. The greater the sensitivity the device has, the weaker the radio signals need to be to ensure that the device can receive from other devices error free. The receiver sensitivity is dependent upon the hard- and software of a device. The receiver sensitivity is maximized in devices with *Bluetooth* from SMA Solar Technology.

4.2 Notes on Installation Site

An ideal installation site in open air without obstacles between devices is not always possible. Certain environmental conditions can reduce the connection quality and data transmission speed between *Bluetooth* devices.

Consider the following points during the selection of a location site:

- The radio range of devices with SMA *Bluetooth* in open air with direct visual contact is up to 100 m, apart from inverters that have been retrofitted with SMA *Bluetooth*.
Due to the inverter housing, the SMA *Bluetooth* Piggy-Back - with which inverters can be retrofitted with SMA *Bluetooth* - only reaches a radio range of up to 50 m in open air with direct visual contact.
- Plan for a buffer for the radio range during installation.
- The radio range in buildings is dependent upon damping materials (walls, ceilings etc.) between devices. See section 4.1.3 "Strength of Damping by Obstacles" (page 18).
- An increase to the radio range is possible through the use of an SMA *Bluetooth* Repeater.
- If possible mount or install the *Bluetooth* device with a clearance of at least 1 m to the following devices:
 - WLAN devices
 - Microwave ovens
 - other devices which use the 2.4 GHz frequency band (e.g. ZigBee devices, some wireless security cameras, certain types of controllers for model airplanes, etc.).

4.2.1 Use of the SMA Bluetooth Repeater

The SMA Bluetooth Repeater is a device which is used in a Bluetooth network when there are radio gaps which need to be closed. Radio gaps can occur at the installation site if it is not possible to install the devices where they are able to be networked, because they have to be set up too far away from each other.

Radio gaps can also occur when unfavorable environmental conditions weaken the radio signals too much.



The SMA Bluetooth Repeater is not an amplifier; it has the same transmitting power as other participants in a Bluetooth network. The SMA Bluetooth Repeater should be placed half way between the devices with a poor radio connection.

An inverter can also be used to bridge a radio gap instead of an SMA Bluetooth Repeater if this is a feasible solution within the PV system.

In the example shown in this illustration, the SMA Bluetooth Repeater can be placed one story, preferably half way, between the communication device and the inverters.

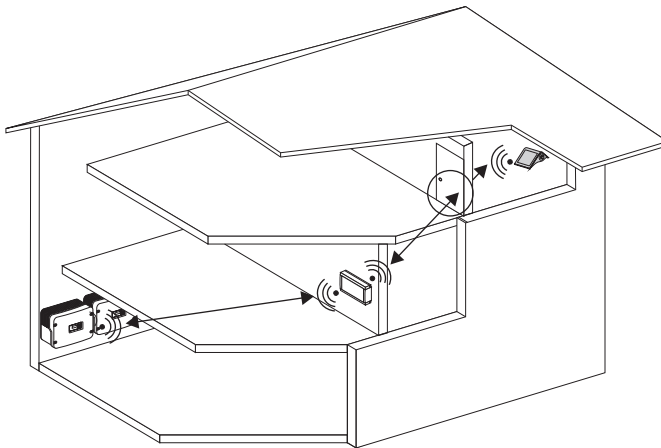

Alternatively, the SMA *Bluetooth* Repeater can be placed directly above the inverters on the same story as the Sunny Beam with *Bluetooth* as in this illustration:

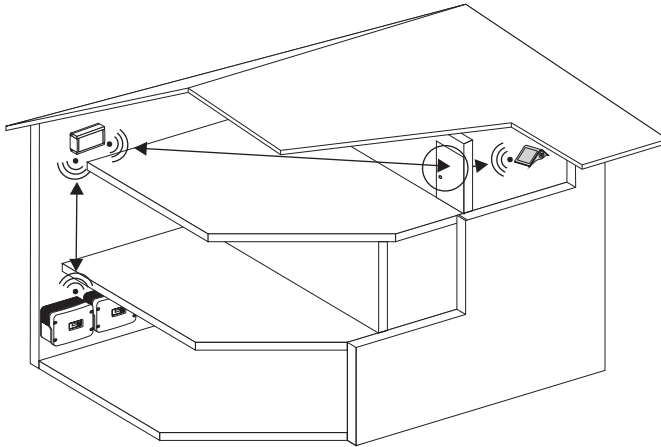

As a result, fewer walls and ceilings have to be penetrated at an angle (see section 4.1.2 "Penetration of Obstacles" (page 17)).

4.3 Diagnostics Facility

Apart from the pure distance between the communication partners, obstacles have a large role to play and can in certain cases completely stop a radio connection. For this reason, SMA Solar Technology has built a simple diagnostics facility for connection quality into its *Bluetooth* devices (see section 5.3 "Check radio connection" (page 29)).

- Inverters with integrated SMA *Bluetooth* (e.g. SB5000TL-20)
 - Blue LED
 - Radio symbol with up to 3 rings in the display
- SMA *Bluetooth* Repeater
 - Blue LED
 - 3 yellow LEDs

5 Commissioning of a *Bluetooth* PV System

The main steps for the commissioning of a PV system with *Bluetooth* from SMA Solar Technology are described in this section. In the "Procedure" section, the main steps for commissioning are listed, and you will find further information for individual main steps in the sections following.

5.1 Procedure

The procedure for commissioning a *Bluetooth* PV system depends upon whether you are commissioning a new *Bluetooth* PV system or whether you want to add devices to an already existing *Bluetooth* PV system.

5.1.1 Commissioning a New *Bluetooth* PV System

The main steps for the commissioning of a new PV system with *Bluetooth* are listed in this section. When carrying out the steps, follow the instructions for the device or the Help section in Sunny Explorer.

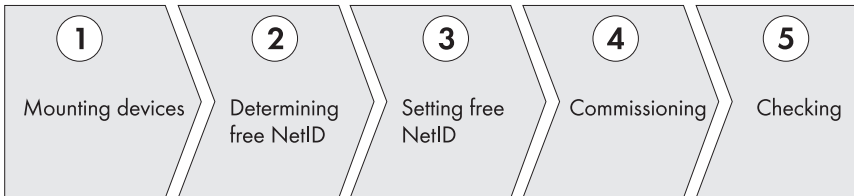

1. Mount or install the device:
 - Inverter, SMA *Bluetooth* Repeater, communication device
2. Determine a free NetID with a mobile communication device.

For example using the Sunny Beam with *Bluetooth* or a laptop with *Bluetooth* and Sunny Explorer software.

How you determine a free NetID is described in section 5.2 "Determining a Free NetID" (page 26).
3. Set the free NetID in the devices:
 - Inverter, SMA *Bluetooth* Repeater
4. Commission the devices:
 - Inverter, SMA *Bluetooth* Repeater, communication device
5. Check radio connection.

How you check the radio connection is described in section 5.3 "Check radio connection" (page 29).

5.1.2 Adding Devices to Existing Bluetooth PV Systems

The main steps on how you add devices to an existing *Bluetooth* PV system are listed in this section. When carrying out the steps, follow the instructions for the device or the Help section in Sunny Explorer.

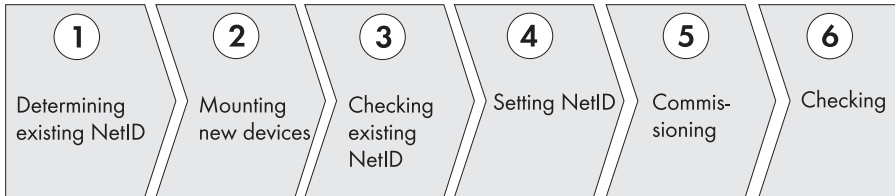

1. Determine the NetID of the existing *Bluetooth* PV system using one of the following methods:
 - Ask the owner of the *Bluetooth* PV system.
 - Read off the NetID from an available Repeater of the *Bluetooth* PV system.
 - Read off the NetID from an available Sunny Beam with *Bluetooth* in the menu "Service > Diagnostics > Device Information > Sunny Beam".
 - When there are no foreign *Bluetooth* PV systems in the neighborhood, you can carry out a system search with a mobile communication device (Sunny Beam with *Bluetooth* or laptop with *Bluetooth* and Sunny Explorer software).
 - Read off the NetID at the NetID rotating switch on an available inverter.

2. Mount or install the new device:
 - Inverter, SMA *Bluetooth* Repeater, communication device
3. Check that the existing NetID is also free at the mounting location.

When enlarging your *Bluetooth* PV system by adding further devices, it can be that the new device is in range of a neighboring system which was previously outside of the radio range of the existing devices. You must check that the existing NetID is not being used by a neighboring system. How you determine a free NetID is described in section 5.2 "Determining a Free NetID" (page 26). However, you only have to check whether the existing NetID is in use by a neighboring system at the mounting location of the new device.

4. Set the new device to the NetID of the existing *Bluetooth* PV system.
 - Inverter, SMA *Bluetooth* Repeater
5. Commission the new devices:
 - Inverter, SMA *Bluetooth* Repeater, communication device
6. Check radio connection of the new devices:
 - Inverter, SMA *Bluetooth* Repeater, communication device

How you check the radio connection is described in section 5.3 "Check radio connection" (page 29).

5.2 Determining a Free NetID

In order that all devices in your *Bluetooth* PV system can communicate with each other, you must set all devices to the same NetID. There are 15 NetIDs available. Further details on the NetIDs are described in section 3.3 "NetID" (page 10).

In order to avoid your system being set to a NetID which is already in use in the neighborhood by another PV system with SMA *Bluetooth*, you must first of all determine a free NetID before commissioning the devices. If you do not determine a free NetID, it could be that you inadvertently set your devices to the same NetID that your neighbor has assigned to his PV system with SMA *Bluetooth*. Your devices would then network into a combined *Bluetooth* PV system with the devices of your neighbor. Depending on the number of devices, the data traffic could be slowed down.



The determination of a free NetID is not necessary for *Bluetooth* PV systems with Sunny Explorer and a single inverter.

You can leave the inverter set to NetID 1 as it is pre-installed for shipping, if your *Bluetooth* PV system consists of the following products:

- 1 Inverter
- up to 2 computers with *Bluetooth* and Sunny Explorer software.

If you use an SMA *Bluetooth* Repeater or a Sunny Beam with *Bluetooth*, you must determine a free NetID. The NetID must be between 2 and F.



Mobile communication device

You need a mobile communication device such as the Sunny Beam with *Bluetooth* or a laptop with *Bluetooth* and Sunny Explorer software in order to be able to determine a free NetID.

Proceed as follows, in order to determine a free NetID:

1. The inverter and SMA *Bluetooth* Repeater should not yet be commissioned. The NetID can be set to 0 (*Bluetooth* switched off) or 1 (pre-installed, connection to 1 communication product only).
2. With a mobile communication device, stand next to a device of the PV system.
3. Start the system search in the Sunny Beam with *Bluetooth* or create a new PV system in Sunny Explorer, as described in the Help section of Sunny Explorer.
 - The NetIDs of the systems found within radio range are displayed. All displayed NetIDs are occupied.
4. If necessary, make a note of the occupied NetIDs or cross them off in the illustration.

NetIDs

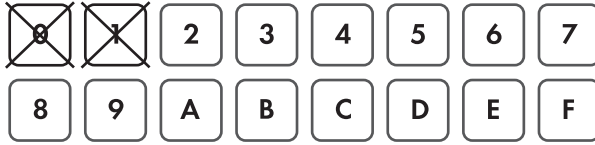

The NetIDs 1 and 0 are already crossed off in this illustration, since *Bluetooth* is turned off when set to NetID 0 and the inverter can not be networked with other inverters or SMA *Bluetooth* Repeaters when set to NetID 1.

- Repeat the system search with the mobile communication device at every device in the PV system. If necessary, again make a note of the occupied NetIDs.

Carry out the system search at these locations: 

Example of a PV system in a house

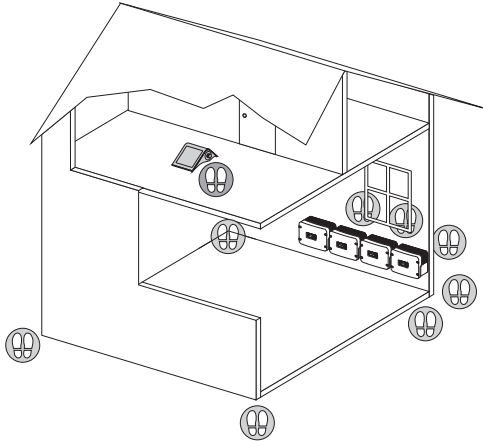

Example of a PV system in a house and on the premises

For larger PV systems, it is sufficient to carry out the system search at devices on the edges of the PV system. The system search does not have to be carried out at devices which are surrounded by other devices.

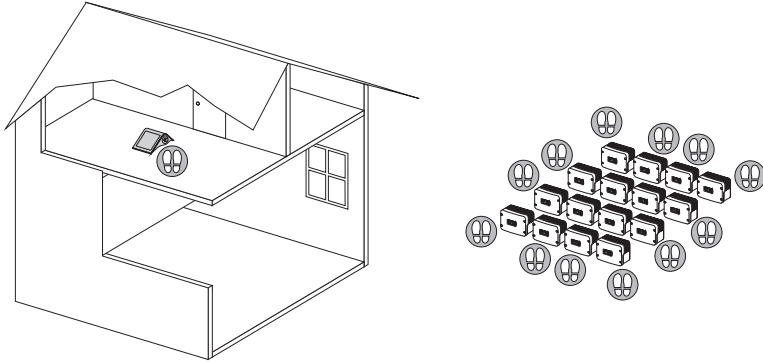

6. Once the system search is completed at every device, select a NetID which was not displayed during the entire system search and is greater than NetID 1.
 - The free NetID is determined.









Now you can set the inverters and SMA *Bluetooth* Repeaters to the free NetID.

5.3 Check radio connection

5.3.1 Inverters with integrated SMA Bluetooth

The inverters with integrated *Bluetooth* from SMA Solar Technology (e.g. SB3000TL-20 / 4000TL-20 / 5000TL-20) have a radio signal (rings) in the display and a blue LED on the front side of the inverter. With these displays you can read the connection quality of the inverter to other devices with SMA *Bluetooth*.









Inverters which have had SMA *Bluetooth* retrofitted by means of the SMA *Bluetooth* Piggy-Back do not have this display capability.

| Inverters with integrated SMA Bluetooth | | | |
|--|--|--------------------|--|
| Status | | Connection quality | Action |
| Blue LED | Rings | | |
|  permanently on |  3 rings | Very good | No action necessary. If necessary, the transmission path distance can be increased. A good connection should, however, be maintained. |
| |  2 rings | Good | No action necessary. |
| |  1 ring | Unreliable | Position SMA <i>Bluetooth</i> Repeater. |
| |  no ring | Critical | Position SMA <i>Bluetooth</i> Repeater. |
|  Permanently off |  no ring | None | Check NetID. Position SMA <i>Bluetooth</i> Repeater. |
|  | | (Special function) | If the blue LED flashes, the inverter is in localization mode with the communication product. |

You can use the special function with Sunny Explorer and inverters with integrated SMA *Bluetooth* in order to located devices with unknown mounting locations in larger PV systems. Once you have located the device, you should supplement the device name with a location-describing appendix in Sunny Explorer.





5.3.2 SMA Bluetooth Repeater

The *Bluetooth Repeater* from SMA Solar Technology has four LEDs, with which you can read the connection quality between the *SMA Bluetooth Repeater* and other devices with *SMA Bluetooth*.

| SMA Bluetooth Repeater | | Connection quality | Measure |
|---|--|-------------------------------|---|
| Status | | | |
| Blue LED | Yellow LEDs | | |
|  Permanently on |  3 LEDs on | Very good | No action necessary. If necessary, the transmission path distance can be increased. A good connection should, however, be maintained. |
| |  2 LEDs on | Good | |
| |  1 LED on | Unreliable | |
| |  No LEDs on | Critical | |
|  Off |  No LEDs on | None | The <i>SMA Bluetooth Repeater</i> is not connected to the <i>Bluetooth</i> network: <ul style="list-style-type: none"> • There is no device with the same NetID within the radio range. <ul style="list-style-type: none"> - Check NetID. - Change the positioning or install additional <i>SMA Bluetooth Repeaters</i>. • The <i>Bluetooth</i> network has not been established. Only masters initiate network establishment. |
| |  3 LEDs flashing | The NetID is incorrectly set. | |

5.3.3 Communication device

The communication devices with *Bluetooth* from SMA Solar Technology have in the menu a display for the reading of the connection quality to other devices with SMA *Bluetooth*.

| Communication device | | |
|--|--------------------|--|
| Status | Connection quality | Action |
| Rings | | |
|  3 rings | Very good | No action necessary. If necessary, the transmission path distance can be increased. A good connection should, however, be maintained. |
|  2 rings | Good | No action necessary. |
|  1 ring | Unreliable | Position SMA <i>Bluetooth</i> Repeater. |
|  no ring | Critical | Position SMA <i>Bluetooth</i> Repeater. |
| No dot | None | Check NetID. Position SMA <i>Bluetooth</i> Repeater. |

6 FAQ

What is *Bluetooth* Class 1?

Bluetooth is available in 3 classes which differ in transmitting powers and therefore their radio ranges.

| Class | Transmitting Power | Radio Range in Open Air |
|-------|--------------------|-------------------------|
| 1 | 100 mW, 20 dBm | ~ 100 m |
| 2 | 2.5 mW, 4 dBm | ~ 10 m |
| 3 | 1 mW, 0 dBm | ~ 1 m |

Can I retrofit my computer with *Bluetooth* Wireless Technology?

You can retrofit your computer with *Bluetooth* using a USB *Bluetooth* Stick. The USB *Bluetooth* stick is connected to a USB port in the computer. If you want to bridge larger distances between devices, you should use a Class 1 USB *Bluetooth* stick.

Can I retrofit my laptop with *Bluetooth* Wireless Technology?

Many laptops already have Class 2 *Bluetooth* Wireless Technology integrated. If you want to use your laptop for mobile applications, the *Bluetooth* Wireless Technology interface integrated in the laptop is sufficient.

If you do not want to use your laptop for mobile applications and want to establish a connection across large distances and through walls, you should use a Class 1 USB *Bluetooth* Stick. Deactivate the *Bluetooth* Adaptor integrated in the laptop when you use a USB *Bluetooth* stick with the laptop. The battery running time is shortened during communication via *Bluetooth* Wireless Technology.

Do I need special software?

You need the "Sunny Explorer" software from SMA Solar Technology in order to be able to establish a connection from your computer to your *Bluetooth* PV system. With Sunny Explorer you can, for example, configure your *Bluetooth* PV system, view the most important system data and the status of the devices as long as the respective devices in the PV system support this function.

Where can I read the set NetID on the inverter?

On an inverter with integrated SMA *Bluetooth* (e.g. SB3000TL-20 / SB4000TL-20 / SB5000TL-20), you can read the set NetID on the rotary switch for the NetID at the inverter. Follow the instructions for the inverter.

On an inverter with retrofitted SMA *Bluetooth*, you can read the set NetID on the rotary switch for the NetID on the SMA *Bluetooth* Piggy-Back. Follow the instructions for the SMA *Bluetooth* Piggy-Back.

Is a PV system with communication via *Bluetooth* and cable possible?

The inverters of a PV system can only be connected to each other via one form of communication. All inverters are either connected via *Bluetooth* Wireless Technology or via a cable-connected form of communication, such as via RS485 communication.

It is, however, possible with a PV system containing inverters only of the types SB3000TL-20 / SB4000TL-20 / SB5000TL-20 which are connected together via RS485 communication, to retrieve data in parallel with a communication device via *Bluetooth* Wireless Technology.

Is *Bluetooth* a danger to health?

According to latest research, the specific absorption rate (SAR) is the basis for evaluation of possible damage to health caused by high frequency electromagnetic fields. The absorption rate describes what amount of the radiant power (measured in Watts (W); 1 W = 1000 mW) is absorbed by a human body (kg).

The maximum allowable SAR amounts to 0.08 W/kg for the complete body and 2.00 W/kg for a part of the body, for example the head.

Devices connected by *Bluetooth* or via WLAN remain far below this SAR limit as individual components. Current results show that a class 1 USB *Bluetooth* stick or a WLAN plug-in card for laptops at a minimum distance to a part of the body only reach an SAR value of approx. 0.1 W/kg.

According to the latest scientific research, there is no proof that if the limits are reached that the high frequency electromagnetic field causes risks to health.

Bluetooth Class 1 is fitted with an automatic transmitting power regulator, which reduces the transmitting power when a good connection is established. Therefore the transmitting power seldom reaches 0.1 W (100 mW).

Which USB *Bluetooth* sticks can I use?

SMA *Bluetooth* supports all USB *Bluetooth* sticks, apart from USB *Bluetooth* sticks from AVM GmbH, for example not "BlueFRITZ!".

7 Glossary

| | |
|--|--|
| AFH | <p>Abbreviation of "Adaptive Frequency Hopping"</p> <p>With AFH there is continuous switching between the 79 <i>Bluetooth</i> channels in random order. Frequencies disturbed by WLAN routers, for example, or those already occupied are ignored.</p> |
| Master | <p>Master is a term from networking technology and used for a participants of a network that requests other devices (Slaves) to receive or transmit data. The communication of the entire network is driven via the Master. In an <i>SMA Bluetooth</i> network the communication devices (e.g. Sunny Beam with <i>Bluetooth</i>) and computers with Sunny Explorer software take on the role of Masters.</p> |
| Root node | <p>In an <i>SMA Bluetooth</i> network the root node is the device which connects directly to a communication device (Master) and initiates the network creation.</p> <p>In an <i>SMA Bluetooth</i> network the root node has a special characteristic: 2 Masters can connect with the root node, all other Slaves can only connect with 1 Master.</p> |
| Repeater (SMA Bluetooth Repeater) | <p>The <i>SMA Bluetooth</i> Repeater is a device which closes radio gaps in the <i>Bluetooth</i> network.</p> <p>The <i>SMA Bluetooth</i> Repeater is a passive participant in the <i>Bluetooth</i> network without its own data traffic. The <i>SMA Bluetooth</i> Repeater is not an amplifier, it passes the data on unchanged.</p> |
| SAR | <p>Abbreviation of Specific Absorption Rate The SAR is a measurement of the absorption of electromagnetic fields in biological tissue. According to latest research, the specific absorption rate is the basis for evaluation of possible damage to health caused by high frequency electromagnetic fields. The absorption rate describes what amount of the radiant power (measured in Watts (W); 1 W = 1000 mW) is absorbed by a human body (kg).</p> |
| Slave | <p>Slave is a term from networking technology and is used for passive participants of a network that are requested by a Master to receive or send data. In an <i>SMA Bluetooth</i> network the inverters and the <i>SMA Bluetooth</i> Repeaters take on the role of Slaves.</p> |

The information contained in this document is the property of SMA Solar Technology AG. Publishing its content, either partially or in full, requires the written permission of SMA Solar Technology AG. Any internal company copying of the document for the purposes of evaluating the product or its correct implementation is allowed and does not require permission.

Exclusion of liability

The general terms and conditions of delivery of SMA Solar Technology AG shall apply.

The content of these documents is continually checked and amended, where necessary. However, discrepancies cannot be excluded. No guarantee is made for the completeness of these documents. The latest version is available online at www.SMA.de or from the usual sales channels.

Guarantee or liability claims for damages of any kind are excluded if they are caused by one or more of the following:

- Damages during transportation
- Improper or inappropriate use of the product
- Operating the product in an unintended environment
- Operating the product whilst ignoring relevant, statutory safety regulations in the deployment location
- Ignoring safety warnings and instructions contained in all documents relevant to the product
- Operating the product under incorrect safety or protection conditions
- Altering the product or supplied software without authority
- The product malfunctions due to operating attached or neighboring devices beyond statutory limit values
- In case of unforeseen calamity or force majeure

The use of supplied software produced by SMA Solar Technology AG is subject to the following conditions:

- SMA Solar Technology AG rejects any liability for direct or indirect damages arising from the use of software developed by SMA Solar Technology AG. This also applies to the provision or non-provision of support activities.
- Supplied software not developed by SMA Solar Technology AG is subject to the respective licensing and liability agreements of the manufacturer.

SMA Factory Warranty

The current guarantee conditions come enclosed with your device. These are also available online at www.SMA.de and can be downloaded or are available on paper from the usual sales channels if required.

Trademarks

All trademarks are recognized even if these are not marked separately. Missing designations do not mean that a product or brand is not a registered trademark.

The *Bluetooth*[®] word mark and logos are registered trademarks owned by Bluetooth SIG, Inc. and any use of such marks by SMA Solar Technology is under license.

SMA Solar Technology AG

Sonnenallee 1

34266 Niestetal

Germany

Tel. +49 561 9522-0

Fax +49 561 9522-100

www.SMA.de

E-Mail: info@SMA.de

© 2004 to 2009 SMA Solar Technology AG. All rights reserved

SMA Solar Technology AG

www.SMA.de

Sonnenallee 1

34266 Niestetal, Germany

Tel.: +49 561 9522 4000

Fax: +49 561 9522 4040

E-Mail: Vertrieb@SMA.de

Freecall: 0800 SUNNYBOY

Freecall: 0800 78669269

